

ADVANCED ENERGY RESEARCH AND TECHNOLOGY CENTER™
RESEARCH PROJECTS

INNOVATION AND EXPLORATION

2019

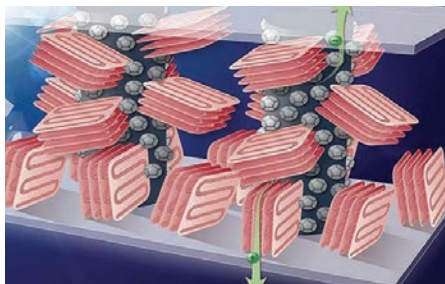

ADVANCED ENERGY™
Research and Technology Center

AT STONY BROOK UNIVERSITY

www.aertc.org



Division of
Science, Technology
& Innovation

ADVANCED ENERGY RESEARCH AND TECHNOLOGY CENTER™ INNOVATION AND EXPLORATION

Emerging technologies and cutting-edge research. Microgrids and smart buildings. Offshore wind and geothermal power. Modern utility grids and alternative fuel vehicles. Today, entrepreneurs, researchers, and engineers are developing bold new advances in energy that will change the industry, and the world, forever. After decades of research and development in renewables, batteries, and other new technologies, the drive toward the development and adoption of cleaner, more sustainable energy is rapidly accelerating – not a moment too soon.

The recent devastation wreaked by Mother Nature across the United States has had a tremendous impact on human lives, the economy, and the environment. From the destruction caused by flooding in Texas to Hurricanes Irma and Maria ravaging Florida and Puerto Rico, these disasters exposed the sweeping changes the energy industry must make to address aging energy infrastructures. The need to rebuild – not just using existing technology, but with state-of-the-art advancements – was never more critical than now.

The Advanced Energy Research and Technology Center™ (AERTC), a NYS Center of Excellence located at Stony Brook University (SBU), partnering with a number of institutions including Brookhaven National Laboratory (BNL), City University of New York, SUNY Farmingdale, NYU-Tandon School of Engineering, and the New York Institute of Technology (among others), represents a unique opportunity to take a national lead in the development of clean technology, alternative and renewable energy technologies, as well as smart grid and energy conservation. Investigators at SBU and BNL have embarked on cutting edge research across a broad spectrum of these new opportunities with the theme of “reliable, affordable, and environmentally sound energy for America’s future.” This publication describes currently funded research programs and projects on a wide variety of advanced energy topics that will impact America’s future, all focused on developing new technologies and driving innovation to ensure the future of energy is always on the cutting edge of industry and research.

As diverse as these efforts are, an overarching theme is the application of nanoscience and nanotechnology to overcome critical barriers. New properties being discovered in familiar materials present many scientific questions, but they also offer the promise of new, more efficient and cost-effective solutions, which are explored at the AERTC within the state-of-the-art Thermomechanical and Imaging Nanoscale Characterization (ThINC) user facility. Advanced Energy Research and Technology Center™ projects involve new generations of students, imbuing them with the knowledge, skills, and awareness of the broader societal implications and economics of energy research and supplies the growing national demand for energy-centric science and engineering graduates. Stony Brook University is consistently listed among the top universities in the world and has among its faculty recipients of both the National Medal of Science and the National Medal of Innovation and Technology and leads the 64-campus SUNY system in earning competitively-awarded federal research funds. BNL has a history of outstanding scientific achievement that spans more than six decades and led to seven Nobel Prizes. Its leadership role is achieved by positioning the BNL’s user facilities: the National Synchrotron Light Source II (NSLS-II), Relativistic Heavy Ion Collider (RHIC) and the Center for Functional Nano-materials (CFN) – in continued leadership positions working in teams with universities and industries. Both Stony Brook University and Brookhaven National Laboratory have long been the SUNY leader in technology transfer, whether measured by licensing fees, invention disclosures, issued patents, or executed licenses. The campuses have a “cradle to Fortune 500” suite of economic development programs, from R&D collaboration to the nurturing of new enterprises with its incubator programs and facilities. The projects described here are a modest representation of the depth and breadth of our commitment to the research disciplines that bear on energy research. Much more needs to be done and our faculty colleagues and industry partners are rising to these challenges. We invite you to join us!

Robert B. Catell
*Chairman of the Board
Advanced Energy Research
and Technology Center*

Dr. Yacov Shamash
*Vice President for Economic Development
Stony Brook University*

Matt Watson
*Vice President
Empire State Development
Division of Science, Technology
and Innovation*



ABOUT THE AERTC

The AERTC engages with with energy-based institutes, laboratories, and programs throughout the country. Our LEED platinum facility at the Stony Brook Research and Development Park supports major research and training centers: Advanced Energy Training Institute (AETI), Center for Integrated Electrical Energy Storage (CIEES), Center for Mesoscale Transport Properties (m2m), Institute for Gas Innovation and Technology (GIT), New York Energy Policy Institute (NYEPI), New York State Center for Clean Water Technology (CCWT), NYSERDA's Clean Energy Business Incubation Program (CEBIP), National Offshore Wind Research and Development Consortium, and Thermomechanical & Imaging Nanoscale Characterization (ThINC). Each of these centers harnesses an expert team of researchers, educators and investigators dedicated to pursuing advanced energy solutions. As the founding organization of the New York State Smart Grid Consortium (NYSSGC), we also work closely with the NYSSGC in bringing together business and government leaders, policy makers and researchers in developing innovative programs to deploy smart-grid technology.

ADVISORY BOARD*

Mr. Robert B. Catell
Chairman of the Board, AERTC
Chairman of the Board, NYSSGC

Mr. Ross Ain, President
Caithness Long Island, LLC
and Executive Vice President
of Caithness Energy, LLC

Ms. Alicia Barton
President and CEO
NYSERDA

Dr. Michael Bernstein
Provost and Senior VP
for Academic Affairs
Stony Brook University

Dr. Vincent Boudreau
President
The City College of New York
(CCNY)

Mr. John Bruckner
President
New York National Grid
National Grid

Hon. Robert E. Curry, Jr.
Senior Advisor
CRA International

Mr. Steven J. DeCarlo
Associate Director,
Utility Services
Maser Consulting P.A.

Mr. Paul A. DeCotis
Senior Director
West Monroe Partners, LLC

Mr. Richard Dewey
Executive Vice President
New York Independent System
Operator (NYISO)

Mr. Daniel Eichhorn
President
PSEG Long Island

Mr. Tom Falcone
CEO
Long Island Power Authority
(LIPA)

Mr. Michael L. Faltischek
General Counsel, AERTC
Founding Partner
Ruskin Moscou Faltischek P.C.

Mr. James T. Gallagher
Executive Director
New York State Smart Grid
Consortium

Dr. Doon Gibbs
Laboratory Director
Brookhaven National Laboratory

Mr. Larry Goldenhersh
President
Center for Sustainable Energy
(CSE)

Mr. Steven Goldman
President and CEO
Star Gas Partners, LLP

Mr. Ross D. Groffman
Executive Director
NextEra Energy Resources, LLC

Mr. Jeffrey Grybowski
Chief Executive Officer
Deepwater Wind

Mr. Jeffrey S. Katz
Head of Grid Technology
Energy, Environment and
Utilities Industry
IBM Corporation

Mr. Richard M. Kessel
Consultant
East Coast Progressive
Energy Solutions

Mr. Robert (Bob) W. Klein
Vice President
Engineering Battle Management
and Engagement Systems
Northrop Grumman Corporation

Dr. Jelena Kovacevic
Dean
Tandon School of Engineering
New York University

Mr. Kevin S. Law
President and CEO
Long Island Association, Inc.

Mr. Gene E. Martin
President and COO
Transmission Developers, Inc

Mr. Guy Mazza
DPS – LI Director
Department of Public Service

Ms. Sangeeta Ranade
Vice President
Clean Energy Business and
Market Development
New York Power Authority (NYPA)

Dr. Yacov Shamash
Vice President for
Economic Development
Stony Brook University

Mr. Lawrence J. Waldman
Treasurer, AERTC
Senior Advisor
First Long Island Investors

Mr. Howard Zemsky
President, CEO
and Commissioner
Empire State Development
Corporation

Mr. David Hamilton
Director of Operations
AERTC

Dr. Miriam Rafailovich
Chief Scientist, AERTC
Department of Materials
Science and Engineering, and
Program in Chemical Engineering
College of Engineering and
Applied Sciences
Stony Brook University

*As of 1/1/19

TABLE OF CONTENTS

ADVANCED ENERGY PARTNERS 6-23

MODELING AND SIMULATION

Simulation of High Power Liquid Mercury Accelerator Targets	24
Clean Power Transition	24
Energy Efficiency Performance Indicators for a Production Line	25
Damage Tolerant 3-D Periodic Interpenetrating Phase Composites with Enhanced Mechanical Performance	25
Optical Pattern Recognition Using Multiple Phase-Shifted Joint Transform Correlation With Log-Polar Transformation	25
Computational Evaluation of New Concept of Magneto-Inertial Fusion	26
Simulation of Advanced Coherent Electron Cooling and Beam-Beam Effects	26
Simulation of Muon Ionization Cooling Devices	27
Integrated Production Line and HVAC System	27
Synchronized Low-Energy Electronically-Chopped Passive-infrared (PIR) Sensor for Occupancy Detection (SLEEPIR)	28
Visual Interface to Aid Energy Aware Layout and Use of Smart Spaces, Buildings, Offices and Industry Facilities	28

ENERGY GENERATORS AND CONVERTERS

Free Cooling of Data Centers	29
Contiguous Platinum Monolayer Oxygen Reduction Electrocatalysts on High-Stability Low-Cost Supports	29
Ultraviolet Curing Assisted Additive Manufacturing for High-Efficiency Thermoelectric Devices	30
Innovative Approach for Low-Cost High-Volume Thermo-Electric Device Manufacture	30
High Performance Supercapacitors Based on Carbon Nanomaterials	31
Creating Self-cleaning Air Purifying Surfaces for Urban and Energy Applications	31
Structure and Function in Electrocatalysis of Reactions for Direct Energy Conversion	32
Enhancing the Damage Tolerance of Plasma-facing Materials for Fusion Reactors	32

ENVIRONMENTAL SUSTAINABILITY

Off-Grid Renewable Power Production Using Wood Waste on Long Island	33
Laser-based High Efficiency Separation of Rare Earth Materials	33
Cleaning Environmental Contamination by Utilizing Novel Membranes, Adsorbents and Catalysts	33
Design Optimization of Electric Buses for MTA New York City Fleets	34
TiO ₂ in Combination with Energy Saving Compact Fluorescent Light Bulbs Exposure May Cause Skin Cells Damage	34
Developing a New Generation of Sustainable Polymer Nanocomposites for Energy and Consumer Applications While Addressing Consumer Safety Issues	35
Research Experience for Undergraduates (REU) site in 'Nanotechnology for Energy, Health and the Environment'	35
A Robust Solar Powered Membrane Distillation System for Drinking Water	36
Environmental Fate of Pollutants	36
Multi-Scale Assessment of the Thermo-Mechanical Behavior of Saturated Clays Subjected to Freeze-Heat Cycles	37
The Effect of Aerosol Particles Emitted by Biomass Burning on Air Quality	37
EcoPartnerships- Landfill Gas Usage Strategies	38
Waste Management and Innovation	38
Off-Grid Power Production in Kenya Using Local Waste Materials	38

RENEWABLE ENERGY

Virtual Wind Simulator with Advanced Control and Aeroelastic Model for Optimizing Land-Based and Offshore Wind Farms	39
High Efficient Refrigerator Using Cool Outside Temperatures	39
Development of a Cost Effective Method for Wind Turbine Maintenance	40
Photocatalysis for Solar Fuel Generation	40
Catalysis for the Generation of Fuels	40
Economics and Economic Impacts of Offshore Wind Energy in Long Island	41
Analysis and Design of Heat Exchangers for a Vuilleumier Natural-Gas Driven Heat Pump	41
Forced-Flow Convective Baseboard for High Efficiency Energy Delivery	42
Pathways to Greening Power and Transportation Sectors	42
Laser-assisted Manufacturing of Multiscale Super-Insulation Material	43
Laser-assisted Chemical Vapor Deposition of Passivation Layers for Organic Devices	43

PHOTOVOLTAIC AND FUEL CELLS

Laser-assisted Photovoltaic Manufacturing and Diagnostics	44
Development of Laser Scribing Technology for High Efficiency Building Integrated Thin-Film Solar Modules	44
Thin Film Solar Cells with Tunable Transparency	45
Nanoparticle Enhancement of Polymer Electrolyte Membrane Fuel Cell Power Output	45
Developing Self-cleaning Glass for Solar Panels	45
Enhancing the Power Output of Polymer Electrolyte Membrane Fuel Cells (PEMFC) Through the Deposition of Monolayer Gold Nanoparticle Platelets onto Nafion® Membranes	46
Development of Monolithic Integration Technologies for Flexible CIGS Solar Modules Using All-Laser Scribing	46
Engineering Environmentally Responsible Flame Retardant Materials for Energy Delivery	47

COMBUSTION

Application of Nanometer and Sub-nanometer Particles for Clean Fuel Production	48
The "Lumburnator": A Next Generation Wood Stove	48
Developing and Investigating the Chemical and Mechanical Aspect of Cu/Zelite Catalysts for Selective Catalytic Reduction of NO _x by NH ₃ (NH ₃ -SCR)	49
Low Temperature Combustion (LTC)	50
Reactivity & Structural Dynamics of Supported Metal Nanoclusters Using Electron Microscopy, In-Situ X-Ray Spectroscopy, Electronic Structure Theories, & Molecular Dynamics Simulations	51
Single-Fuel Reactivity Controlled Compression Ignition Combustion Enabled by Onboard Fuel Reformation	52
Miniature Internal Combustion Engine for Transformational Residential Applications (MICE TRAP)	53
Dedicated Beamline Facilities for Catalytic Research: Synchrotron Catalysis Consortium (SCC)	53
Naphthenic Biofuel-Diesel Blend for Optimal Mixing Controlled Compression Ignition Combustion	54
Design of Nanostructured Tungsten Alloys for the Future of Fusion Energy	55

BIOENERGY AND BIOFUELS

Alternative Pathways for Biofuel Formation from Furfuryl Alcohol Over Heterogeneous Catalysts	56
-----------------------------------------------------------------------------------------------------	----

Fundamental Research of Cu/Zeolite Catalyst During NO _x Selective Catalytic Reduction: Structure-Catalytic Activity Relationship.....	56
Development of Cost-Effective Technology for Biogas Purification.....	57
Development of a Flex Bio-Plant: Microemulsion-based Production of Bio-methanol and Bio-butanol from Biomass-derived Synthesis Gas.....	57
Technical and Evaluation Analysis of Advanced Strategies for the Energy Valorization of Biomass	57
Microflow of Highly Viscous Fluids: Mixing and Dissolution Processes... ..	58
NanoSulf™ Process for Effective Sulfur Removal	58
Institute of Gas Innovation and Technology (I-GIT)	58
Design of Microchemical Systems for Discovery of Methane Science.....	58
Turning Waste into Fuels, Soil Additives and Improved Construction Materials.....	59
New Biomimetic Materials to Produce Hydrogen from Water.....	59
Assessment of Reforming Energy Vision (REV) Projects	59
Developing Moderate Heterogeneous Catalytic Routs for the Conversion of Furan Derivatives into Chemicals and Liquid Hydrocarbon Fuels	60
Development of Novel Materials for CO ₂ Conversions into Fuels	61
Studying Catalysts Used for Energy and Environmental Applications Under Working Conditions.....	61
Understanding Mechanistic Aspects of Biofuels Production.....	61
Biomass Derived Furan/Furan Derivatives' Biofuel Products over Heterogeneous Catalysts.....	62
Biogas Management for Power and Transportation Fuels Production... ..	62
Development of Nanaocatalysts for Fuels from CO ₂ -Enriched Syngas using a Si-Microreactor	63
A Simple Approach to Prepare Carboxycellulose Nanofibers from Untreated Biomass	63
Nanotoxicology of Particles Commonly Used for Energy Applications: A Collaboration Between the AERTC and the School of Dental Medicine	64
Investigation of the Catalytic Activity for CO Oxidation on Boron Nitride Nanotubes (BNNTs).....	65
Catalytic Activity of Cu/CHA on the NH ₃ -SCR Reaction	65
BATTERY AND STORAGE RESEARCH	
Multimodality X-ray Imaging at Nanometers	66
Multifunctional Cathode Additives for Li-S Battery Technology	66
High Capacity Anode Investigation	67
Types of Government Supports in Energy Technology Innovation: The Case of Li-ion Battery Technologies	67
Carbon Nanomaterials for High Performance Supercapacitors	67
Workload-Aware Storage Architectures for Optimal Performance and Energy Efficiency.....	68
Dual Function Solid State Battery with Self-Forming Self-Healing Electrolyte and Separator	68
Sulfur Loaded MS2 Barrier for Control of Polysulfide Shuttling in Lithium Sulfur Batteries	68
Nanomaterials and Nanostructures for Energy Storage Applications.....	69
In-situ and In-operando Analysis of Energy Storage Materials	69
Improved Batteries for Implantable Cardiac Defibrillators.....	70
New Materials for Stationary Grid-Scale Energy Storage.....	71
Novel Materials Yielding High Energy, High Power, and Improved Reversibility.....	71
Regenerable Battery Project	72
StorEn Vanadium Flow Battery.....	72
Chemists Develop MRI-Like Technique to Detect What Ails Batteries.....	73
Multifunctional Cathode Additives for Li-S Battery Technology	73
System (ESS) and Renewable Energy Sources.....	73

SMART POWER MANAGEMENT

Design Methodologies for Low Power 3-D Integrated Circuits	74
The Effect of Web Optimizations on Mobile Power and Performance	74
Enhanced Power Systems Operation and Control	74
Enhancing Mobile Apps to Use Sensor Hubs Without Programmer Effort ..	75
Low Power Clocking Methodologies for Nanoscale CMOS Circuits.....	75
An Efficient, Versatile, Scalable, and Portable Storage System for Scientific Data Containers	76
Automatic Optimal Phase Balancing Algorithms for Electric Utilities	76
Adaptive Runtime Verification and Recovery for Mission-Critical Software	77
Quantitative Musings on the Feasibility of Smartphone Clouds.....	77
TTP: Small: NFS4Sec: An Extensible Security Layer for Network Storage	77
MCloud: Secure Provenance for Mobile Cloud Users.....	78
Thermoelectrically Driven Sensing for Nuclear Power Plants	78
Evaluation of the Bureau of Energy Resources (ENR) Unconventional Gas Technical Engagement Program (UGTEP)	79
DIMMER: A Case for Turning Off DIMMs in Clouds	79
Evaluation of Additive Manufactured Composites for Energy Applications....	79
EcoHadoop: A Cost-Efficient Data and Task Co-Scheduler for MapReduce	79
Smart Meter Security Testing.....	79
Condensing Flue Gas for Sub-Ambient Evaporative Cooling and Cool Storage.....	80
Fundamental Research of 2D Zeolite.....	80

SMART GRID AND MICROGRID

Secure, Reliable and Integrated Smart Grid Solutions Under Variable Weather Conditions	81
Smart Grid Integration of Energy and Information Technologies for Energy IT, Inc.....	81
Analytics Framework for Understanding Household Energy Consumption.....	82
Dynamic Islanding as an Accelerant for Grid Restoration and Enhancement to Reliability.....	82
Smarter Electric Grid Research, Innovation, Development, Demonstration, Deployment Center (SGRID3)	82
Smart Grid National Energy Control Center	82
Smart Grid Android Manager	83
Transportable Energy Storage for Enhancing Power Grid Resiliency to Natural Disasters	83
Electrical Grid Monitor System (EGMS) Based on Modern Sensor, Communication and Computational Technologies	83
Controlling Non-Synchronous Microgrids for Load Balancing of Radial Distribution Systems	84
Centralized Unbalanced Dispatch of Smart Distribution dc Microgrid Systems	84
Smart Load Management of Distribution-Class Toroidal Transformers Using a Dynamic Thermal Model	84
Impacts of Severe Weather Events on the Carrying Capacity of Distribution Grid	85
An Interactive User Interface for the Smart Grid.....	85
Resilience Benefits of Distributed Energy Resources	85

EDUCATION AND OUTREACH

The Additive Manufacturing Materials, Prototyping and Applications Center (AMMPAC)	86
The Long Island Alternative Energy Consortium	87
The Advanced Energy Conference Series	88

RESEARCHERS	90
--------------------------	----

ADVANCED ENERGY TRAINING INSTITUTE



Ms. Patricia Malone

CORE INSTITUTION

Stony Brook University

Stony Brook University, Center for Corporate Education (CCE), brings its expertise in professional and industry certification to the Advanced Energy Training Institute (AETI) which includes new and innovative programs in energy and sustainability, ranging from sustainable project and business management skills to green building, energy efficiency, power and smart power. Working with core partners, such as the U.S. Green Building Council (USGBC, USGBC-LI, and the Advanced Energy Center partners including NYSERDA, PSEG, NYPA, National Grid, IBM and others, the Advanced Energy Training Institute is identifying new credentialing venues, linking and clustering certification programs, conducting focus groups and engaging statewide agencies and partners to create a platform for honest credential brokering in sustainability and smart energy.

PROGRAM SAMPLING:

LEED Training

Leadership in Energy and Environmental Design (LEED) Green Building Rating system, developed by the US Green Building Council (USGBC) provides a suite of standards for environmentally sustainable construction. LEED certification is the nationally accepted benchmark for the design, construction and operation of high performance buildings.

LEED Accreditation (GA & AP)

LEED Green Associate (GA) Exam Preparation course prepares participants for the rigors of the LEED GA Exam. LEED GA is the first step in becoming a LEED Accredited Professional (AP). LEED AP Exam Preparation course is also offered.

Leadership

The STEM fields are central to tackling the world's most complex problems, from global challenges, to economic efficiency, to reducing air pollution – the possibilities are endless. CCE Leadership programs teach building high performance teams, organizational culture, the human dynamics of leading and how to manage conflict. Courses include: Leadership Certificate; Women in STEM Leadership Program

Project Management and Business Analysis

Project Management and Business Analysis program enrich skills that promote project efficiency, tighter cost and time management, enhanced communication of objectives and better use of human resources. Business Analysis

Quality and Continuous Improvement/Lean/Six Sigma

For businesses looking to create a competitive advantage, CCE provides a blueprint to lean transformation and the attainment of operational excellence. By applying these continuous improvement principles, businesses can achieve greater efficiency and profitability. Companies learn how to improve their operations with a systematic focus on customer needs, quality improvement, and waste elimination, while empowering your employees and fostering faster throughput. Courses include: Introduction to Continuous Improvement, Certified Lean Professional, Certified Six Sigma Green Belt and Black Belt; ISO; Internal Auditing.

Management/Professional Development

The role of an effective manager/supervisor is to get each employee working to her or her maximum potential. CCE course help develop the skills of top managers. Courses include: Supervisory Skills/ Managerial Effectiveness, Customer First Culture, Cybersecurity, Team Building.

Smart Grid Workshops

The smart grid promises to increase the efficiency of today's electric system and save billions of kilowatt-hours each year. The Smart Grid applies information technology, tools and techniques so the grid runs more efficiently. The current electric grid is inefficient for meeting today's demands. When customers know how much energy they use, usage will reduce. Today's demands on energy created the need for alternative solutions to our electric system which is over a century old. Upgrades are necessary to traditional power plants ~ Smart Grid will increase energy efficiency in a smart, lower-carbon way!

- Security Issues in the Smart Grid
- Educate & Incentivize Consumers to Save Energy
- Smart Grid Modeling
- Wireless Networking for Smart Grid
- Smart Grid Optimization - How The Grid Becomes Smart
- Visualization of Smart Meter Data
- Business Opportunities in Smart Grid Security
- Wireless Networking for the Smart Grid

FUNDING

Stony Brook University

CONTACT

AETI Executive Director

Ms. Patricia Malone

Stony Brook University

sbucce@stonybrook.edu

PARTNERS



Center for Corporate Education

AT STONY BROOK UNIVERSITY



**CENTER FOR
 INTEGRATED ELECTRIC
 ENERGY SYSTEMS**



*Dr. Benjamin S. Hsiao
 CIEES Director*



*Dr. Vyacheslav Solovyov
 CIEES Deputy Director*



*Dr. Esther Takeuchi
 CIEES Team Leader*



*Dr. James Misewich
 CIEES Team Leader*

CORE INSTITUTION

Stony Brook University

The goal of the Center for Integrated Electric Energy Systems (CIEES), established by a NYSTAR Center for Advanced Technology (CAT) award from the Empire State Development's (ESD's) Division of Science, Technology and Innovation, is to make New York State a global leader in technologies that will accelerate the progress of renewable energy as one of the main-stream resources displacing fossil fuel-based electric power worldwide.

The current mission of CIEES is to enhance the integration of advanced technologies into electric energy systems on multiple scales, and to foster the development of new technologies to promote the innovative nexus of food-energy-water systems (INFEWS). In fulfilling its mission, CIEES intends to substantially increase New York enterprises and jobs in this critical energy subsector by leading commercialization of technologies that will:

- (1) improve resiliency, reliability, and efficiency for the energy systems;
- (2) reduce the state's carbon footprint;
- (3) develop new economic opportunities for the state.

The CIEES partnership will support new technology development with programs providing advanced technology assistance for R&D through new product development and marketing, which will leverage unique SBU and BNL programs and facilities to support new and expanding energy technology enterprises. CIEES will also engage energy providers, distributors and environmental institutions to draw support for initiatives aimed at generating and growing the private energy business, and will also work with two technology consortia, the New York State Smart Grid Consortium (NYS-SGC) and the New York Battery and

Energy Storage Technology Consortium (NYBEST) in accordance with the New York State energy roadmap and public needs.

Key scientific and technology challenges have kept abundant, affordable green energy out of reach. While technologies for electrochemical energy storage and renewable resources continue to advance, there is a critical lag in the development of storage for electric grid applications and technologies for grid integration of the stored energy, essential for system stability for intermittent renewables, e.g., wind and solar. CIEES will build upon the exceptional research base in energy storage and electric grid distribution at Stony Brook University (SBU) –including SBU's DOE-funded \$10M Energy Frontier Research Center (EFRC) in energy storage and \$12M joint Smart Grid Demonstration Project– and its key partner, Brookhaven National Laboratory (BNL). Acting initially through three closely interacting thrusts in (1) energy storage, (2) grid management for integration, and (3) new, cost effective and sustainable INFEWS technologies. In specific, CIEES will apply these institutions' formidable intellectual horsepower to surmount such technology challenges as scaling electrochemical energy storage chemistries and safely engineering batteries, and developing sensors and control systems for enabling two-way power flow, managing state-aware dispatch of distributed storage resources, grid cyber security at all scales, develop energy efficient water purification and treatment technologies, and develop advanced energy materials. Beyond these initial thrusts, the CIEES will address additional needs as they emerge in its focus areas.

During our second year in operation, CIEES started seven new projects with NY companies, addressing technologies ranging from synthetic fuels to additive manufacturing and energy storage. All of these activities shared one common goal: realizing our vision of Long Island as the 'Valley' of renewable energy and smart grid.

As renewable energy sources continue to penetrate the traditional grid, new sets of technological challenges continue to emerge: economical storage of large amounts of energy, managing variable electric loads, and cybersecurity of the grid. Our area of operation, Eastern Long Island, is the ideal testbed for new energy technologies, as our large population density, high land cost and large swings of seasonal power consumption drive the demand for out-of-box energy solutions. Our first CIEES workshop, held in October 2017 at Stony Brook University Technopark, pulled together small businesses, energy utilities and academics from NY State, and enabled the workshop team to outline a practical roadmap towards the renewable energy future of downstate NY.

We enter 2018 with a new crop of energy projects aimed at demonstration of value of large scale in-grid energy storage technologies for NY communities. We will be taking continued strides towards elevating CIEES as a hub of energy and grid innovations, where our long-term objective is to become a "go-to" place with rapid prototyping and testing capabilities to support and enhance transformative energy technologies for New York State and beyond.

CONTACT

Director

Dr. Benjamin Hsiao
Distinguished Professor, Chemistry
Stony Brook University
Benjamin.Hsiao@stonybrook.edu

Deputy Director

Dr. Vyacheslav Solovyov
Adjunct Professor,
Electric Engineering
Stony Brook University
Vyacheslav.Solovyov@Stonybrook.edu

Team Leader

Dr. Esther Takeuchi
Distinguished Professor,
Chemistry & Materials Science
Stony Brook University
Chief Scientist
Brookhaven National Laboratory
Esther.Takeuchi@stonybrook.edu

Team Leader

Dr. James Misewich
Associate Laboratory Director
Brookhaven National Laboratory
Professor, Physics and Astronomy
Stony Brook University
misewich@bnl.gov

PARTNERS



CENTER FOR MESOSCALE TRANSPORT PROPERTIES: MOLECULAR TO MESOSCALE OVER TIME



Dr. Esther Takeuchi



Dr. Amy Marschilok

CORE INSTITUTIONS

Stony Brook University
Brookhaven National Laboratory

m2m Center for Mesoscale Transport Properties



AT STONY BROOK UNIVERSITY

The Advanced Energy Research and Technology Center is home to the Center for Mesoscale Transport Properties, an Energy Frontier Research Center (EFRC) funded by the U.S. Department of Energy (DOE). The Director of the Center is renowned energy storage researcher, Professor Esther Takeuchi, with accomplished scientist Dr. Amy Marschilok acting as Center Operations Officer. In addition to Stony Brook University, the Center has five University participants and two national laboratory participants. The Center for Mesoscale Transport Properties is funded by a four-year \$12 million grant.

The Scientific Mission of the Center is to build the scientific knowledge to enable creation of scalable electrochemical energy storage systems with high energy, power, and long life, through identification and purposeful probing of localized resistance of materials and interfaces under dynamic conditions from the molecular to the mesoscale.

The research proposed under this renewal award leverages the insights gained over the prior four-year period to enable simultaneous high power, high energy, scalable electrical energy storage systems. This will be achieved through a focused and integrated effort with access to state-of-the-art theoretical and experimental tools to study the transport of relevant species (ions, electrons, and mass), redox reaction kinetics, and chemical transformation of the associated complex interfaces in working electrochemical cells.

FUNDING

Department of Energy (DOE)

New York State Energy Research and Development Authority (NYSERDA)

Empire State Development's Division of Science, Technology and Innovation (NYSTAR)

CONTACT

m2m EFRC Director

Dr. Esther Takeuchi

Stony Brook University

Esther.Takeuchi@stonybrook.edu

m2m Center Operations Officer

Dr. Amy Marschilok

Stony Brook University

Amy.Marschilok@stonybrook.edu

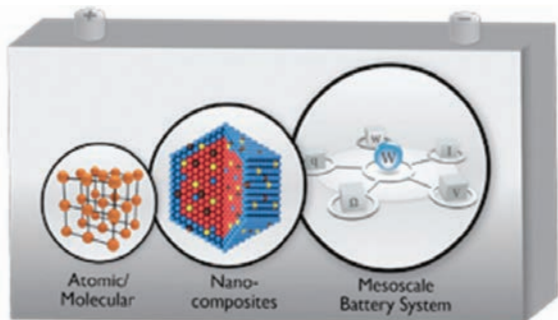

Polythiophene π -conjugated backbone and carboxylated side chains, respectively, generate π - π interactions with single-walled carbon nanotube surface and carboxylate bonds with hydroxylated electroactive particles, which allows for stable electrical networks. This connection effectively captures pulverized/cracked particles, leading to high performance in lithium-ion batteries. Research at the Center featured on the May 2, 2018 issue of JACS.

PARTNERS





Institute of Gas Innovation and Technology

AT STONY BROOK UNIVERSITY

INSTITUTE OF GAS INNOVATION AND TECHNOLOGY (I-GIT)



Dr. Devinder Mahajan

CORE INSTITUTIONS

Stony Brook University
National Grid

An Integrated Gas Energy Institute

A collaboration between Stony Brook University's Advanced Energy Research and Technology Center (AERTC) and National Grid, I-GIT is a consortium composed of academic and industry leaders working together to find clean and affordable solutions to meet the nation's growing energy demands and challenges.

I-GIT is administered within AERTC, where it is housed with offices and state-of-the-art laboratories. Its expert team of researchers, educators and investigators are working closely with the clean-tech community to bring together business and government leaders, policymakers and researchers in developing innovative programs to deploy advanced energy technologies.

THERE ARE FIVE PILLARS THAT DEFINE I-GIT

1. A transition to low-carbon technologies

I-GIT will focus on hybrid fuel technologies through the introduction of various renewable sources, such as gas, hydrogen, fuel cell, geothermal and thermal heat.

2. Gas technology gap analysis

Preparing and maintaining a gap analysis will provide I-GIT opportunities to support environmental, societal and economic development goals.

3. Workforce training

To meet future needs, I-GIT will use AERTC's corporate training program and develop graduate certificate programs with member input.

4. Becoming an international consortium

I-GIT will build upon AERTC's existing relationships with other countries, including China, Japan, Korea and the United Kingdom, to increase membership and establish a global advanced technologies exchange mechanism.

5. Leveraging industry funding

To help expand its funding base, I-GIT will work with state and federal agencies.

For more information about I-GIT, visit stonybrook.edu/gas-innovation



U.S. – CHINA

STRATEGIC AND ECONOMIC DIALOG

A U.S. DEPARTMENT OF STATE

INITIATIVE

CONTACT

Director

Dr. Devinder Mahajan
Jefferson Science Fellow,
U.S. Department of State
Stony Brook University
Devinder.Mahajan@stonybrook.edu

PARTNERS



SUSTAINABLE DAIRY TECHNOLOGIES

**NEW YORK
ENERGY POLICY
INSTITUTE**



Dr. Elizabeth Hewitt

CONTACT

Dr. Elizabeth Hewitt
Executive Director
Stony Brook University
Elizabeth.Hewitt@stonybrook.edu

NYEPI Moves forward

The New York Energy Policy Institute (NYEPI) is about to undergo a major redirection in strategy and focus, under the leadership of Dr. Elizabeth Hewitt, the newly appointed Executive Director of NYEPI.

While remaining focused on energy, NYEPI will begin to align its approach to address the new challenges and opportunities associated with cutting-edge opportunities that are emerging out of big data and artificial intelligence research. Specifically, NYEPI will support the current strategic realignment of its home department at Stony Brook University, the Department of Technology and Society. Technology and Society has set a new strategy focused on the “4 Smarts” – development, communities, education and ethics. For three of these the energy connection is obvious:

- **Smart Development:** The grand challenge of development stems from the fact that modern civilization arose using energy resources, largely fossil fuels, with increasingly obvious negative environmental consequences. Going forward smart development will be needed to help the rest of the world develop without locking in continuing undesirable consequences.
- **Smart Communities:** Increasing urbanization and societal complexity is creating a great new set of opportunities for how people live together and consume energy and resources. The litany of smart buildings, smart grid, smart transportation and their interconnections frame the importance of big data and the internet of things to the future of human habitation.

- **Smart Ethics:** The temptation to, and perhaps the necessity of, allowing our systems to operate with increasing autonomy and diminished human intervention raises important ethical considerations. Issues ranging from energy poverty to the establishment of the roles and limits of robotics and artificial intelligence in society only scratch the surface of the ethical and moral dilemmas that lie ahead.

Dr. Hewitt brings critical experience to NYEPI. Dr. Hewitt is trained as an urban planner and social scientist, and her work explores energy and resilience in buildings and cities. Dr. Hewitt received her PhD from the Bloustein School of Planning & Public Policy at Rutgers University, and her doctoral studies were funded by a National Science Foundation (NSF) IGERT fellowship for interdisciplinary energy research. She is also LEED-accredited by the United States Green Building Council.

“This is a critical time for NYEPI to refocus its direction, as New York State, New York City and the region continue to advance strong clean energy agendas such as the comprehensive statewide Reforming the Energy Vision (REV) strategy. NYEPI has an opportunity to develop key partnerships and forge new synergies to advance cutting edge research,” Dr. Hewitt explained.

NYEPI began in 2010 as a consortium of New York universities and Brookhaven National Laboratory. Initial funding for the institute came from NYSERDA. Under that support, the staff provided analysis of policy options, maintained a database of energy experts and conducted workshops.

In the coming year, NYEPI will emphasize the development of strategic partnerships and the building of a sound funding base, and will focus on targeted outreach, a seminar series and networking workshops.

Stony Brook University Center for Clean Water Technology

THE NEW YORK STATE CENTER FOR CLEAN WATER TECHNOLOGY



Dr. Christopher Gobler

CORE INSTITUTION

Stony Brook University

CONTACT

Director

Dr. Christopher Gobler

Christopher.Gobler@stonybrook.edu

Administrator

Hilary Wolfskill

Hilary.Wolfskill@stonybrook.edu

The New York State Center for Clean Water Technology (CCWT) was borne out of a local problem—contamination of ground and surface waters with nitrogen and other contaminants.

THE PROBLEM

Suffolk County is home to more than 1.5 million people and 74% of homes are un-sewered. The wastewater from individual homes is discharged to antiquated cesspools and septic tanks that deliver nitrogen and other contaminants to groundwater.

Discharge of these contaminants into groundwater has two major impacts:

1. Nitrogen-rich groundwater is having a cascading negative effect within marine ecosystems where it is contributing to the loss of salt marshes and seagrass, as well as the expansion of harmful algal blooms that degrade water quality and threaten fisheries and human health. In a region where tourism, recreational boating and commercial fishing represent billion-dollar industries that are dependent on water quality and fisheries, excessive nitrogen loading represents a serious environmental and economic threat to Suffolk County.
2. Contamination of the sole source aquifer in Long Island creates additional challenges in providing clean drinking water to communities, since there are no reasonably available alternative drinking water sources. Septic tank leakage in addition to legacy contamination that resulted from industrial practices, continue to degrade the quality of groundwater resulting in an increased exposure to toxic contaminants by Long Island residents.

While there now exists technologies that remove more nitrogen and other emerging contaminants from waste streams than standard cesspools and septic tanks, these technologies are not without their shortcomings. They are expensive, have large infrastructure footprints and limited effectiveness, presenting challenges for widespread adoption.

Beyond nitrogen from wastewater, Long Island groundwater and drinking water has been contaminated by industrial and household pollutants such as 1,4-dioxane and perfluorinated compounds. CCWT is also investi-

gating processes that may be most effective in removing these compounds from drinking water supplies.

A WIDESPREAD CHALLENGE

The challenge of water quality degradation caused by nutrient loading and other contaminants is a scenario that is widespread across the nation and beyond. Twenty-five percent of homes in the United States have cesspools and septic tanks (US Census Bureau), infrastructure that is not designed to remove nutrients and other emerging contaminants. Further, in many instances the homeowners and water utilities are often unprepared to remove complex contaminants from drinking water supplies. In short, the contamination of water has become a major issue throughout the United States and across the globe.

THE SOLUTIONS

New technologies are needed to optimize nutrient and emerging contaminant removal from household wastewater and drinking water that is affordable, reliable, effective, and suitable for widespread deployment. Further, the solutions that are developed for Long Island will be marketable to other regions, states and nations because of the global nature of this problem.

THE CENTER

The Center for Clean Water Technology represents a collaborative, multidisciplinary initiative marshaling the best science and engineering to develop innovative solutions to our water quality problems. Funded by New York State through its Environmental Protection Fund and the Environmental Facilities Corporation, the Center is a nexus for both innovation and entrepreneurship, recognizing that significant economic opportunity lies in developing solutions to this critical environmental problem.

FUNDING

- New York State Environmental Protection Fund as administered by the Department of Environmental Conservation
- New York State Environmental Facilities Corporation
- New York State Department of Health
- Bloomberg Philanthropies
- Rauch Foundation



NEW YORK STATE SMART GRID CONSORTIUM



Robert B. Catell



James T. Gallagher



Elizabeth Taveras

CORE INSTITUTION

A consortium of leading utility,
industrial, academic and
research organizations.

The AERTC is a founding member and strategic partner in the New York State Smart Grid Consortium (Consortium). The Consortium is a unique public-private partnership that brings together the world's leading utilities, technology providers, policy makers and research institutions to identify opportunities that promote the modernization of the grid in New York State. To accelerate the adoption of new technologies, regulation and market mechanisms, the Consortium seeks to facilitate collaboration among the various stakeholders within the State.

The primary mission of the Consortium is to continuously advocate for smart grid implementation by both the public and private sector. While agnostic with respect to specific technologies, the Consortium is committed to educating the public and assisting regulators, policy makers and investors in assessing the potential benefits of technology and the appropriate extent of the commitment by New York's utilities, technology providers, educational institutions, research laboratories and public agencies to the deployment of advanced energy technology.

The Consortium is currently focused on the following priority initiatives:

1. Actively support the New York Public Service Commission's (PSC) Reforming the Energy Vision (REV) proceeding.
 - a. The New York State Public Service Commission (PSC) commenced its REV initiative to reform New York State's energy industry and regulatory practices. This initiative is intended to lead to regulatory changes that promote more efficient use of energy, deeper penetration of renewable energy resources such as wind and solar, along with wider deployment of distributed energy resources such as microgrids, on-site power supplies and storage. Its objective is to also promote greater use of advanced energy management products to enhance demand elasticity and efficiencies. These changes, in turn, will empower customers by allowing them more choice in how they manage and consume electric energy.
2. Support the implementation of Innovative Smart Grid Projects across New York State and beyond.
 - a. The Consortium's current efforts involve participation in a project, funded by the Department of Energy (DOE) Advanced Research Projects Agency - Energy (ARPA-E) for the development of a Distributed System Operator (DSO) Simulation tool. The effort has been led by ProsumerGrid, a software development company focused on innovative DER simulation, planning and coordination solutions.

Most recently, ProsumerGrid and the Consortium signed a Memorandum of Understanding (MOU) with the Puerto Rico Electric Power Authority (PREPA) to utilize the DSO Simulation tool as a way to inform the next Integrated Resource Plan (IRP) required by PREPA. This effort is extremely timely considering the destruction caused by Hurricane Maria to the Puerto Rican electric grid. The result of the grid redesign will include a multi-layer system architecture and redesign along with associated recommendations.

3. Identify research and best practices in Smart Grid Deployments in New York State and the rest of the world to facilitate shared learning.
 - a. Working closely with its members, the Consortium is preparing an inventory of key initiatives that showcase New York as a leader in energy innovation. The objective is to create a platform for those in the industry to easily access all information related to the initiatives efforts. Topics will include REV, offshore wind, NY Prize, and others. The portal is designed to provide a resource to be utilized by New York stakeholders as well as national and international stakeholders eager to learn more about the State's efforts.

CONTACT

Chairman

Robert B. Catell
rcatell@nyssmartgrid.com

Executive Director

James T. Gallagher
jgallagher@nyssmartgrid.com

Project Manager

Elizabeth Taveras
etaveras@nyssmartgrid.com

PARTNERS



JASMINE





Clean Energy Business Incubator Program

AT STONY BROOK UNIVERSITY



David C. Hamilton

CORE INSTITUTION

Stony Brook University

Executive Director

David C. Hamilton

The Clean Energy Business Incubator Program (CEBIP) provides assistance and resources for developers of renewable and clean energy technologies. By mentoring entrepreneurs CEBIP helps them establish successful enterprises to bring their technologies to market. Bringing an innovation to market can be a difficult process requiring technical and business guidance, successful acquisition of funding, and continuing to retain a competitive advantage.

CEBIP's goal is to incubate "green technologies by helping to develop and commercialize them, and to create and sustain growth companies. CEBIP's aim is the creation of high-paying cleantech jobs and industry within New York State that addresses current and future clean energy needs. CEBIP seeks to address many key needs of an early-stage, energy-based technology business, which is especially critical in today's rapidly-changing marketplace. We have assembled an unsurpassed team of partners and access to unparalleled resources to maximize prospects of startups and new business ventures.

The problem of energy cost and supply is the preeminent economic challenge for New York State. As the fourth greatest energy user among the fifty states, with the second highest electricity costs, New York State has a double incentive to address this problem. New York State's net consumption is estimated to cost \$60 billion dollars, or 6.6% of the gross state product, and clean energy solutions hold promise for state-based companies. Solutions must critically lower the cost of energy production in the state, and also become products that will enter the worldwide stream of commerce and bring financial rewards, thereby providing good jobs for New Yorkers and tax revenues for the state.

Enormous investments in basic research at Long Island's research institutes will continue to yield early stage technologies that need feasibility testing, decisions on how and when to enter the commercial development pathway, and securing financing. CEBIP has assembled an unsurpassed team of partners to maximize prospects of start-ups and young ventures augmented by our participation in the Clean Energy Innovation Collaborative with a single point of continuing contact for clients to call on these resources as needed.

CEBIP has brought some of Long Island's leading industry experts together to provide guidance and direction to our clients. The CEBIP Advisory Board is comprised of business leaders and clean energy experts that have real-world experience and can offer invaluable advice. The CEBIP Management Team, with extensive industry knowledge and access to a wealth of resources, is an excellent source point for the clean energy entrepreneur. In addition, CEBIP can tap into the invaluable knowledge and experience of faculty and staff both at Stony Brook University and Brookhaven National Laboratory. We also have the capability of accessing the NYSERDA funded Entrepreneurs in Residence Initiative, which can bring like-minded individuals together for brainstorming and networking.

CEBIP has access to the vast professional services and technological resources that Long Island has to offer. The Small Business Development Center at Stony Brook, which is one of twenty-three campus-based regional Small Business Development Centers within New York State, brings together the resources of the University, the private sector and government at all levels to assist entrepreneurs, business and industry in the solution

of their problems, leading to increased productivity and profitability. CEBIP also can team with the Long Island Angel Network (LIAN) to help with obtaining new business venture start-up capital. CEBIP clients will also have access to Stony Brook University research facilities:

- Center in Integrated Electric Energy Systems (CIEES) to accelerate the program of renewable energy.
- The Strategic Partnership for Industrial Resurgence (SPIR) utilizes the extensive engineering resources of the SUNY system to help local industry compete more effectively.
- Center for Biotechnology offers leading experts in biorenewable energy.
- Stony Brook Office of Technology Licensing and Industry Relations for patents and IP Technology Transfer.
- The Advanced Energy Research and Technology Center (AERTC) is the leader in advanced energy technology research within New York State.

CEBIP is fully committed to helping clean energy technology companies bridge the gap between invention and market using the expertise, business acumen and technological resources of our management team, Advisory Board and extensive partners. We will continuously work towards the development of a successful clean energy economy on Long Island, with the ultimate goal of creating new jobs and having a strong economic impact here in New York.

CEBIP operates directly under the direction of the Long Island High Technology Incubator (LIHTI). LIHTI is a non-profit organization dedicated to helping new technologically-innovative companies to grow by providing them with a variety of support resources and services. CEBIP is financially supported by the New York State Energy Research and Development Agency (NYSERDA). NYSERDA strives to facilitate change through the widespread development and use of innovative technologies to improve the State's energy, economic and environmental wellbeing.

CONTACT

Executive Director

David C. Hamilton

Stony Brook University

David.Hamilton@stonybrook.edu

www.cebip.org

PARTNERS



National Offshore Wind Research and Development Consortium



Robert B. Catell
Chairman

FUNDING

NYSERDA

United States Department of Energy

The National Offshore Wind Research and Development Consortium is a nationally focused, independent, not-for-profit organization funded by the United States Department of Energy (DOE), the New York State Energy Research and Development Authority (NYSERDA), and led by key offshore wind industry stakeholders and research institutions. Based at Stony Brook's Advanced Energy Research and Technology Center (AERTC), the Consortium is dedicated to managing industry-focused research and development of offshore wind to maximize economic benefits for the U.S.

REDUCE COST AND RISK OF OFFSHORE WIND

The goal of the Consortium is to prioritize, support, and promote research and development (R&D) activities that reduce cost and risk of offshore wind development projects throughout the U.S. while supporting U.S.-based manufacturing and the offshore wind supply chain.

Specific technical objectives are aligned with the 2016 National Offshore Wind Strategy published by the DOE and include:

- Advancing offshore wind plant technology
- Developing innovative methods for wind power resource and site characterization
- Developing advanced technology solutions for installation, operation and maintenance, and supply chain

ADDRESS BARRIERS TO IMPLEMENTATION

The Consortium will support initiatives that address specific barriers to implementing offshore wind in the U.S. Key elements of the Consortium's approach include:

- Leadership by an independent board of directors made up of public and private sponsors as well as representatives from U.S. national labs and utilities
- Establishment of diverse advisory groups made up of research partners, investors, manufacturers, and other key industry stakeholders
- Development of a prioritized, national research strategy for incorporating stakeholder input
- Research project awards through competitive solicitations
- Regular engagement with stakeholders and advisory groups

TECHNICAL SOLUTIONS TO REDUCE COST

The Consortium will prioritize research directly applicable to the technical barriers faced by offshore wind developers, original equipment manufacturers (OEMs), and the supply chain. The goals are to identify and encourage the pursuit of technical solutions that reduce U.S. offshore wind levelized cost of electricity (LCOE)* and increase opportunities for the U.S. manufacturing and supply chain establishment. By demonstrating value to endusers, the Consortium will chart a path to financial self-sufficiency and continue its work well beyond the initial four-year award period.

MAJOR PARTICIPANTS

United States Department of Energy (DOE) – the federal agency charged with ensuring the security and prosperity of the US by addressing energy, environmental, and nuclear challenges through transformative science and technology solutions.

New York State Energy Research and Development Authority (NYSERDA) – a public benefit corporation that advances innovative energy solutions with extensive experience commercializing new technologies and spurring private investment.

Advanced Energy Research Technology Center (AERTC) at Stony Brook University – a partnership of academic institutions, research institutions, energy providers and industrial corporations focused on efficiency, conservation, renewable energy and nanotechnology applications for new and novel sources of energy.

The Carbon Trust – a world leader in offshore wind R&D and administrators of the Offshore Wind Accelerator, a self-sustaining European consortium to commercialize research investment.

Renewables Consulting Group (RCG) – a leading offshore wind consultancy in the US with more than a decade of experience and a deep understanding of the U.S. offshore wind market and supply chain.

CONTACT

Chairman

Robert B. Catell
Robert.Catell@stonybrook.edu

Principal Investigator

Richard Bourgeois, PE
richard.bourgeois@nyserd.ny.gov

PARTNERS



**THERMOMECHANICAL
 AND IMAGING
 NANOSCALE
 CHARACTERIZATION**

The Thermomechanical and Imaging Nanoscale Characterization (ThINC) is a core facility of the Advanced Energy Research and Technology Center™ (AERTC) serving the engineering, chemistry, physical and life science communities. It is dedicated to establishing partnerships between Stony Brook University and industrial laboratories for enabling cutting-edge research in nanoscience.

art microscopy and metrology instrumentation, with experienced scientists, who are available to teach and guide users in their use and finding the best approach to understanding their needs in nanotechnology. If needed, the scientists will then guide the users in drafting proposals for using additional instrumentation available at the BNL-CFN. Our facility opens doors to regional industry and students, providing them with educational resources allowing them to explore, innovate, and go further into the world of nanotechnology.

The facility houses wet and dry laboratories, sample preparation suites, and state of the



Dr. Miriam Rafailovich

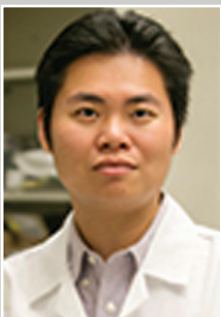

Dr. Chung-Chueh

ELECTRON MICROSCOPY

Focused Ion Beam-Scanning Electron Microscope (FIB-SEM, Zeiss Xbeam 340)

- FE-SEM combines the 3D imaging and analytical performance of the GEMINI column with the ability of FIB for material processing and sample preparation on a nanoscopic scale
- Variable Pressure mode available
- Multiple detectors available: Inlens Duo (SE and BSE mode), SE2, VPSE, EDS and EBSD
- Capella FIB column with Ga-Liquid metal ion source
- Capable of cryo FIB-SEM

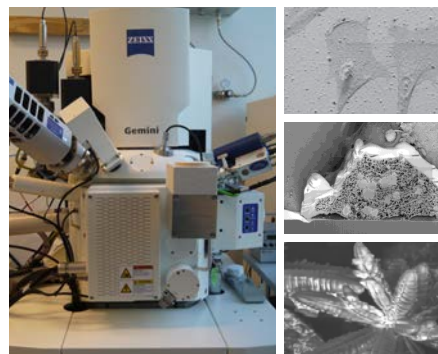

Transmission Electron Microscope (TEM, JEOL JEM 1400)

- Precentered single-crystal LaB6 filament, achieve high resolution of 0.38nm
- Accelerating voltages: 40~120kV at the step of 20kV
- Suitable for materials science, polymer and biological applications
- Features available: Cryotomography, STEM, EDS for elemental identification

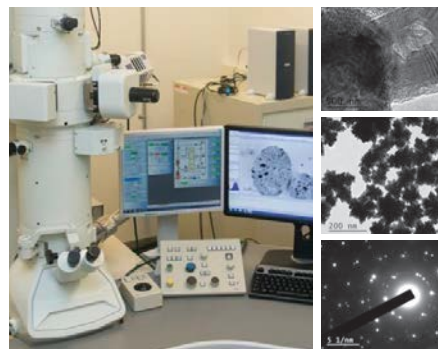

CORE INSTITUTION

Stony Brook University

Chief Scientist, AERTC

Dr. Miriam Rafailovich

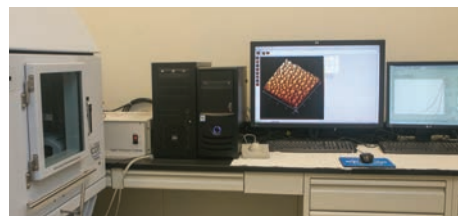

SCANNING PROBE MICROSCOPY

Atomic Force Microscope (AFM, Bruker Dimension ICON)

- Nanomechanics/ nanoindentation
- Nanoelectrical characterization
- Imaging in air/ fluid
- Heating and cooling stages
- Multi-modes available, including: Contact, Tapping and ScanAsyst modes

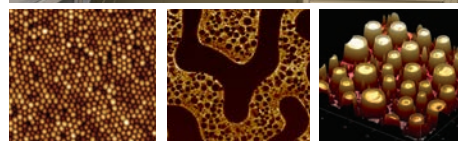

LIGHT MICROSCOPY

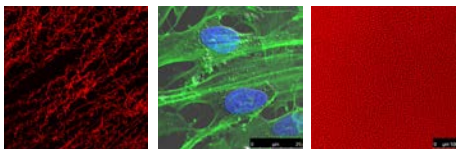
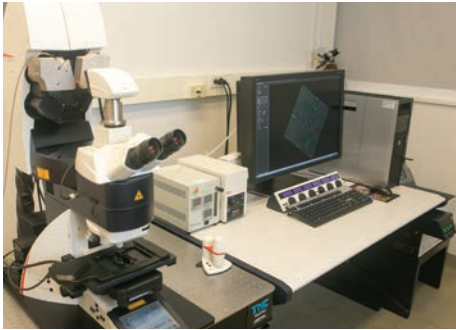

Upright Confocal Microscope
(Leica TCS SP8 X)

- Upright geometry suitable for materials science applications with opaque samples or substrates
- Immersion lenses permit imaging of submerged samples
- GaAsP hybrid detection system (HyD)
- White light laser 470~670nm, and UV laser 405nm
- Tokai Hit stage incubator providing 37°C and 5% CO₂ (live cell imaging)

Fluorescent Microscope (AMG EVOS FL)

- Light Cubes:
DAPI (Ex 360/ Em 447 nm)
GFP (Ex 470/ Em 525 nm)

White (non-transparent samples)

- Equipped with 4~40x LWD objectives and 100x coverslip-corrected oil objective
- Equipped with Biopetechs stage temperature controller providing 37°C for live cell observation

THERMOMECHANICAL CHARACTERIZATION

Dynamic Mechanical Analysis (DMA, TA Q800)

- Temp. range: -145~600°C

Differential Scanning Calorimetry (DSC, TA Q2000)

- Temp. range: -90~550°C

Thermal Gravimetric Analysis (TGA, TA Q50)

- Temp. range: ambient +5~1000°C

Thermal Conductivity Meter (DTC300)

- Temp. range: -20~300°C
- Thermal conductivity range: 0.1~40W/mK



SAMPLE PREPARATION

Ultramicrotome & Cryo-ultramicrotome
(Leica EM UC7/ FC7)

Freeze plunger (FEI Vitrobot)

High Vacuum Coater/ Freeze Fracture Unit
(Leica EM ACE 600)

Cryo Transfer SEM sample Holder (Leica VCT 100)

Cryo Transfer TEM Specimen Holder
(Gatan Gat-626)

Turbo Freeze Drier (EMS 775)

- Comprehensive sample preparation station for microscopy characterization including EM, LM and SPM
- Conventional biological sample preparation for EM characterization
- Rapid plunge freezing for Cryo-fixation and Cryo EM characterization
- Applicable samples including polymer, gels, emulsions and biological samples

CONTACT

Dr. Miriam Rafailovich
Chief Scientist, AERTC
Miriam.Rafailovich@stonybrook.edu

Dr. Chung-Chueh Chang (Simon)
Instrumentation Scientist, AERTC
Chung-chueh.Chang@stonybrook.edu

MODELING AND SIMULATION

Simulation of High Power Liquid Mercury Accelerator Targets

PI: Roman Samulyak, SBU

The targetry group of DOE's Muon Accelerator Program (MAP) is exploring the feasibility of high power liquid mercury targets for future particle accelerators. The numerical simulations aim to describe the hydrodynamic response of the target interacting with proton pulses in magnetic fields and provide input for the design of reliable targets. Simulations use FronTier, a multiphysics code with explicit resolution of material interfaces based on front tracking, a smooth particle hydrodynamics code, and a newly developed Lagrangian particle code that significantly improves accuracy of previous particle-based methods. We have performed simulations of liquid mercury jet targets interacting with high power proton beams in magnetic fields. MHD simulations which predicted strong distortion of the jet entering a 15 Tesla solenoid and the reduction of the target efficiency have led to a change of design parameters for the CERN MERIT

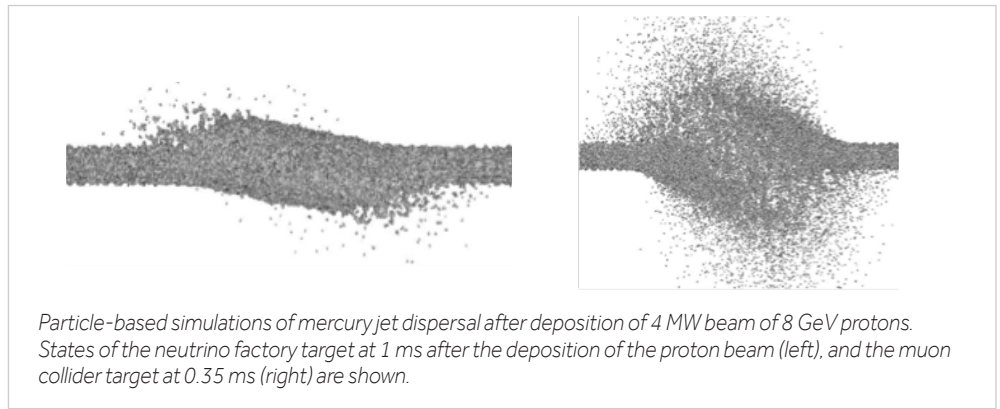

experiment. Simulation also predicted strong instabilities and cavitation of the mercury jet interacting with proton pulses at zero magnetic field and a stabilizing effect of the magnetic field. The main conclusion of the targetry program is that liquid mercury jet targets can reliably work in future accelerators and neutron sources up to 8 MW power limit. This research resulted in unique computational tools that will be able to serve as a design tool for future accelerator and neutron source targets. (DOE HEP)



Publications:
R. Samulyak, W. Bo, X. Li, K. McDonald, H. Kirk, *Computational algorithms for multiphase magnetohydrodynamics and applications*, Condensed Matter Physics, 13 (2010), No 4, 43402: 1 - 12.
R. Samulyak, H.C. Chen, H. Kirk, K. McDonald, *Simulation of high-power mercury jet targets for neutrino factory and muon collider*, Proceedings of PAC2013, Pasadena, CA USA, paper TUPBA09 (2013).

Clean Power Transition

PI: Gang He, SBU

"Electrifying energy use and decarbonizing electricity" is a key strategy for global energy transition. China's power sector presents the best case to study clean power transition as it is now the world single largest coal consumer and as a result is the biggest CO₂ emitter. The clean transition of world's largest power sector will have a significant impact on how China, and to a large extent, the world - uses energy and addresses climate change. This project explores the roadmaps to achieve high penetration of renewable energy and low carbon power supply in China where coal dominates current supply mix. This project develops and expands SWITCH-China (a loose acronym for Solar, Wind, Hydro, and Conventional generation and Transmission Investment) model to analyze least-cost generation, storage, and transmission capacity expansion for China under various policy and cost scenarios, especially with high penetration of renewables. SWITCH uses an unprecedented combination of spatial and temporal resolution with extensive data mining to

design realistic power systems and plan capacity expansion to meet policy goals and carbon emission reduction targets at minimal cost. This project also develops an integrative modeling tool to study the energy-X nexus issues to study the trade-offs between the interactive energy-X nexus. The project explores the energy landscape change from political, economic and institutional perspectives beyond technology. (SBU, University of California at Berkeley)



Stony Brook University



Publications:

G. He, D. M. Kammen. *Where, when and how much wind is available? A provincial-scale wind resource assessment for China*. Energy Policy, 74:116-122 (2014).
G. He, A. Avrin, J.H. Nelson, J. Johnston, A. Mileva, J. Tian, D. M. Kammen. *SWITCH-China: A Systems Approach to Decarbonizing China's Power System*. Environmental Science and Technology, 50(11):5467-5473 (2016).
G. He, D. M. Kammen. *Where, when and how much solar is available? A provincial-scale solar resource assessment for China*. Renewable Energy, 85:74-82 (2016).
G. He, H. Zhang, Y. Xu, X. Lu, Editors. Special Issue. *Environmental Challenges and Potential Solutions of China's Power Sector: Resources, Conservation and Recycling*. Volume 121, Pages 1-164 (2017).
J. Hu, L. Huang, M. Chen, G. He, H. Zhang. *Impacts of Power Generation on Air Quality in China - Part II: Future Scenarios*. Resources, Conservation and Recycling, 121:115-127 (2017).

MODELING AND SIMULATION

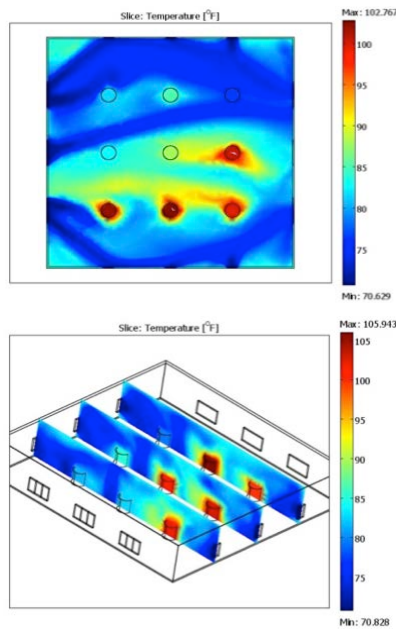

Top (2m from the floor) and side views of temperature distribution within a facility with 9 stations under HVAC control.

Energy Efficiency Performance Indicators for a Production Line

PI: Qing Chang, SBU

Modern manufacturing facilities lack the proper indicators to truly capture energy performance of a production line. Our work creates new energy efficiency performance indicators, which separates usable energy from energy waste to give floor managers the ability to easily see which machines are running efficiently. These indicators differ from current performance measures because they utilize real time data and do not simply just use energy per part, which does not always correctly identify the energy waste in a system. We use these indicators in conjunction with energy savings opportunities to optimize the energy efficiency of the overall production system. (GM)



Publications:
 M. Brundage, Q. Chang, S. Wang, S. Feng, G. Xiao, and J. Arinez. *Energy Savings Opportunities and Energy Efficiency Performance Indicators for a Serial Production Line*. APMS 2013 International Advances in Production Management Systems (2013).
 Q. Chang, G. Xiao, S. Biller, et. al. *Energy Saving Opportunity Analysis of Automotive Serial Production Systems*. IEEE Transaction on Automation Science and Engineering DOI: 10.1109/TASE.2012.2210874 (2012).

Damage Tolerant 3-D Periodic Interpenetrating Phase Composites with Enhanced Mechanical Performance

PI: Lifeng Wang, SBU

The research objective of this project is to study high-performance polymer periodic interpenetrating phase composites (IPCs) with enhanced mechanical properties (including stiffness, strength, impact resistance, toughness, energy dissipation and damage tolerance) through an integrated approach combining design, fabrication, analysis and experiment. Geometries based on triply periodic minimal surfaces and 3-D microtrusses will be used to optimally design microstructures of the proposed IPCs and 3-D direct-write printing technologies will be employed to fabricate them. Analytical and computational micromechanics models will be developed to simulate the IPCs and various tests will be conducted to characterize the fabricated IPCs and to validate the proposed models. It is anticipated that the findings of this proposed research will provide guidelines for engineering and tailoring IPCs to achieve optimized properties. (NSF)



Optical Pattern Recognition Using Multiple Phase-Shifted Joint Transform Correlation With Log-Polar Transformation

PI: M. N. Islam, Farmingdale State College

Optical joint transform correlation (JTC) technique utilizes optical lens and can recognize a pattern of interest efficiently, where the processing can be done at the speed of light. To enhance the correlation performance, a multiple phase-shifted reference based JTC (MRJTC) technique is developed, which produces a single correlation peak for each potential target in a given input scene. To further improve the discrimination between a target and a non-target object, a fringe-adjusted filter is incorporated in the proposed system. Finally, a log-polar transform algorithm is developed for the MRJTC technique to make the pattern recognition invariant to scale and rotation variations. At the correlation plane, the peak-to-side lobe ratio is measured and compared to a threshold to detect and track a pattern of interest in an unknown input scene. The proposed system is simulated with various input scenes where a successful and efficient pattern recognition performance is observed. (U.S. Army)



Publication:
 M.N. Islam, *Proceedings of International Conference on Optics, Photonics and Lasers, Barcelona, Spain, May (2018)*.

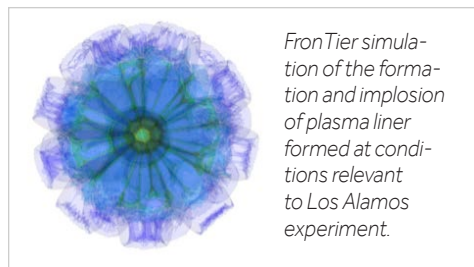

From Tier simulation of the formation and implosion of plasma liner formed at conditions relevant to Los Alamos experiment.

Computational Evaluation of New Concept of Magneto-Inertial Fusion

PI: Roman Samulyak, SBU

In the Plasma-Jet driven Magneto-Inertial Fusion (PJMIF) concept, a plasma liner (formed by the merger of a large number of radial, highly supersonic plasma jets) implodes on a magnetized plasma target and compresses it to conditions of the fusion ignition. By avoiding major difficulties associated with both the traditional laser driven inertial confinement fusion and solid liner driven MTF, the plasma-liner driven magneto-inertial fusion potentially provides a low-cost and fast R&D path towards the demonstration of practical fusion energy. Front tracking technologies have been used for the computational evaluations of the PJMIF concept. Simulations demonstrated the successful formation of the plasma liner by the merger of plasma jets and estimated the uniformity and thermodynamic state of the liner. The uniformity of the liner is critical for the reduction of Rayleigh-Taylor instabilities in the target while maintaining a high Mach number in the liner is necessary to achieve high target compression rates. Our simulations quantified the influence of oblique shock waves on the liner formation and the role of atomic processes in improving the liner quality and target compression rates. They have also investigated processes leading to target instabilities, deconfinement time and verified theoretical scaling laws. Simulations support experimental effort at Los Alamos National Laboratory. (DOE FES)



Publications:

- R. Samulyak, P. Parks, L. Wu, *Spherically symmetric simulation of plasma liner driven magnetoinertial fusion*, Physics of Plasmas, 17, 092702 (2010).
- H. Kim, R. Samulyak, L. Zhang, P. Parks, *Influence of atomic processes on the implosion of plasma liners*, Physics of Plasmas, 19:082711 (2012).
- H. Kim, L. Zhang, R. Samulyak, P. Parks, *On the structure of plasma liners for plasma jet induced magnetoinertial fusion*, Phys. Plasmas 20, 022704 (2013).

Simulation of Advanced Coherent Electron Cooling and Beam-Beam Effects

PI: Roman Samulyak, SBU

The new BNL LDRD project, led by V. Litvinenko (SBU-Physics Department and BNL-CAD), focuses on theoretical, computational and experimental studies of the newly proposed method of Advanced Coherent electron Cooling (ACeC or Micro-Bunching e-Cooling). This approach promises to be superior to any of the current cooling schemes or proposed ones and has a capability to greatly increase the intensity frontier of future particle accelerators. The simulation program, led by R. Samulyak, will achieve proof-of-principles simulations of advanced coherent electron cooling for e-RHIC, address the efficiency of ACeC and fundamental questions of the dynamics of short electron bunches. In particular, the important problem of the reduction of shot noise. High fidelity numerical simulations will aid theoretical and experimental work at CAD. We will also perform computational evaluation of methods for plasma suppression of beam-beam effects in RHIC. In particular, we will simulate electromagnetic fields in plasma created by highly relativistic, colliding proton beams and optimize plasma parameters that lead to the most efficient suppression of beam-beam

effects. We will also study the generation of plasma in RHIC by the proton beam ionization of neutral gases. If the beam-generated plasma proves to be of insufficient density, models for external plasma discharges will be used. On the applied mathematics side, the research will result in the development of new computational models and fast algorithms that will combine in a state-of-art software for the simulation of electrodynamics of particles and fields optimized for modern architecture supercomputers. Such a code will increase research capabilities at BNL. The developed software will also be applicable to numerous high-priority BNL applications such as electron gun, energy recovering linac, aspects of the muon ionization cooling such as the interaction of muons with plasma in absorbers, and advanced laser / wake-field methods for the acceleration of hadron beams. (BNL LDRD)

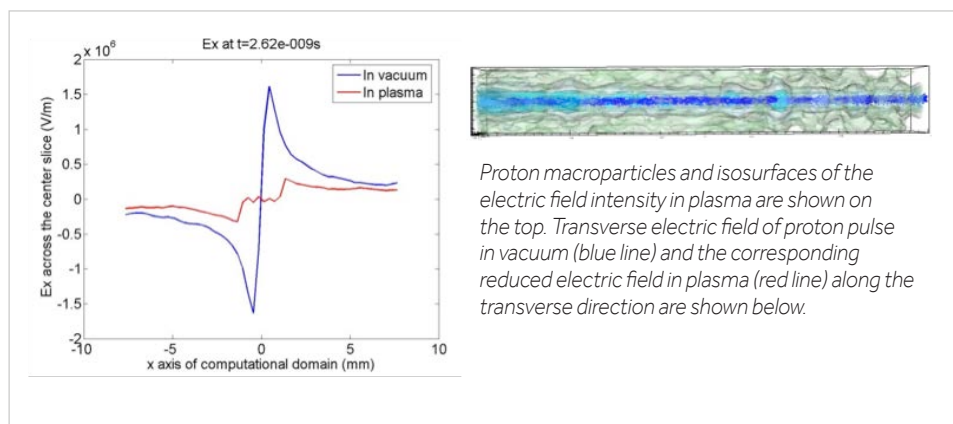

Proton macroparticles and isosurfaces of the electric field intensity in plasma are shown on the top. Transverse electric field of proton pulse in vacuum (blue line) and the corresponding reduced electric field in plasma (red line) along the transverse direction are shown below.

MODELING AND SIMULATION

Simulation of Muon Ionization Cooling Devices

PI: Roman Samulyak, SBU

The aim of this project is to develop novel mathematical models, highly scalable software for modern supercomputers and perform simulations of muon cooling devices in support of the DOE Muon Accelerator Program. Understanding of the interaction of muon beams with plasma in muon cooling devices is important for the optimization of the muon cooling process. A dense hydrogen gas-filled radio-frequency (RF) cavity has been proposed for muon beam phase space cooling and acceleration. An important issue in high-pressure gas-filled radio-frequency (HPRF) cavity is an RF power loading due to beam-induced plasma. Incident particle beam interacts with dense hydrogen gas and causes a significant ionization level. Due to high frequency of collisions with neutrals, electrons reach equilibrium within picosecond time scale and move by the instantaneous external electric field. These charged particles, mainly electrons, absorb power of the electromagnetic field in the cavity. Thus, subsequent bunches following the first one will experience a reduced external field. This external field drop effect is strengthened by the repetitive beam inflow. The recombination process mitigates the side effects of plasma loading. In order to intensify the electron-capture process, electronegative gas is used in cavity. Atomic processes are critical for the performance of the cooling device and should be modeled accurately in simulations. The aim of the current simulation program is the development of mathematical and numerical models and parallel software for the simulation of processes occurring in gas-filled RF cavities. A parallel electromagnetic particle-in-cell code with atomic physics, called SPACE, has been developed at Stony Brook University / BNL. It implements the finite difference time domain method, new mathematical models and numerical algorithms for the interaction of high-energy beams with neutral gas and plasmas. In particular, a novel algorithm dealing with repetitive beam is developed and implemented. Our simulations have achieved good agreement with HPRF experiments performed at Fermi National Accelerator Laboratory. The experimentally verified code is being used for the prediction of new muon cooling regimes that are not achievable by current experimental devices. (DOE HEP)

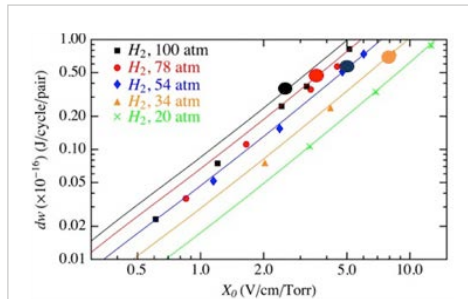

SPACE code simulation of plasma loading of high-pressure hydrogen gas filled RF-cavity at Fermi National Accelerator Laboratory. Comparison of simulation results (large circles), theoretical calculations (solid lines), and experiments (small dots) are shown.



Publications:

R. Samulyak, H.C. Chen, H. Kirk., K. McDonald, Simulation of high-power mercury jet targets for neutrino factory and muon collider, Proc. NA-PAC paper TUPBA09 (2013).
R. Samulyak, K. Yu, M. Chung, A. Tollestrup, K. Yonehara, R. D. Ryne, Algorithms for self-consistent simulations of beam-induced plasma in muon cooling devices, Proc. NA-PAC, paper MOPBA06 (2013).
K. Yu, R. Samulyak, M. Chung, A. Tollestrup, K. Yonehara, Modeling and simulation of beam-induced plasma in muon cooling devices, IPAC, Paper MOPME043 (2014).

Integrated Production Line and HVAC System

PI: Qing Chang, SBU

We have created an integrated thermal and production system model to optimize energy and monetary savings in a manufacturing plant. Utilizing simulation methods, we have combined the two largest energy consumers in a manufacturing facility: the production line and the HVAC system. By joining these two systems, we created an overall control scheme to coordinate shut offs of certain machines without any throughput loss on the production line. These timed shut offs are called opportunity windows. The opportunity windows for the production line are synced with the peak periods of energy demand for the HVAC system to optimize the energy cost savings. (GM)



Publications:

M. Brundage, Q. Chang, D. Chen, and V. Yu, Energy Savings Opportunities of an Integrated Facility and Production Line, Proceedings of ASME 2013 Manufacturing Science and Engineering Conference (2013).
M. Brundage, Q. Chang, Y. Li, G. Xiao, and J. Arinez, Energy Efficiency Management of an Integrated Serial Production Line and HVAC System, 9th IEEE International Conference of Automation Science and Engineering (2013).

RESEARCHER PROFILE



Energy Projects:
Smart grid
Visual modeling

Arie E. Kaufman Distinguished Professor of Computer Science and Radiology, former Chair of Computer Science (1999-2017)

Awards and Honors:

- Fellow, National Academy of Inventors (NAI) (2017-)
- Fellow, IEEE (1998-)
- Fellow, ACM (2009-)
- Member, European Academy of Science (2002-)
- Chief Scientist, Center of Excellence in Wireless and Information Technology (CEWIT) (2007-)
- IEEE Visualization Career Award (2005)
- Entrepreneur Award, State of New York (2002)
- Innovative Research Award, State of New York (2005)
- Long Island Technology Hall of Fame Inductee (2013)
- Editor-in-Chief, IEEE Transactions on Visualization and Computer Graphics (TVCG) (1995-98)

MODELING AND SIMULATION

Synchronized Low-Energy Electronically-Chopped Passive-Infrared (PIR) Sensor for Occupancy Detection (SLEEPIR)

PI: J. Longtin, SBU and
Y Wang, Texas A&M

Residential buildings represent a large fraction of U.S. annual energy use for heating and cooling. In spite of their energy usage, most residential buildings implicitly assume that the occupants are home at all times, and provide heating or cooling accordingly.

This project will develop an advanced, low-cost occupancy sensor for residential homes by building upon commercially available pyroelectric infrared (PIR) sensor technology to detect human presence. When residents are determined to not be home by the system, the heat or cooling temperatures are adjusted for energy savings until the occupants return. The SLEEPIR innovation relies on the use of a solid-state, liquid crystal display (LCD)-based "optical chopper", which temporarily interrupts the flow of heat to the sensor and allows the device to detect both stationary and moving individuals.

Unlike mechanical choppers, the solid-state LCD has no moving parts and is silent, thus improving reliability and reducing electrical power consumption. The technology is built around low-cost, commercially available PIR sensors, which are inexpensive, widely available, proven to be reliable, and use very little power. The sensor system will use Bluetooth 5 protocol, allowing each sensor to communicate to its nearest neighbor to feedback to the main controller, which will override the house thermostat if occupants are determined not to be home. Privacy concerns are minimized, as the PIR sensor is a single light sensor, rather than a camera or microphone-based solution. A machine-learning algorithm will be used to establish daily patterns for the occupants

to increase the predictive capability of the system, while also reducing false negatives, i.e., the system assuming that house is vacant when residents are actually present. Challenges for the project include finding the optimal material(s) for the LCD optical chopper, enabling differentiation between pets and people, ensuring that occupants continue to be detected during quiescent times in the home, e.g., sleeping or watching TV, and minimizing power use.

The system will be powered by a small solar cell with a supercapacitor. For locations in dimly lit rooms, a long-life button battery will be used to keep the battery charge interval infrequency (several years). System feedback to the residents will be provided in terms of smart phone apps and in-house display units to indicate the energy saved with the device, thus reinforcing the positive aspects of the system while minimizing the tendency to override the system. (ARPA-E SENSOR Program)



Visual Interface to Aid Energy Aware Layout and Use of Smart Spaces, Buildings, Offices and Industry Facilities

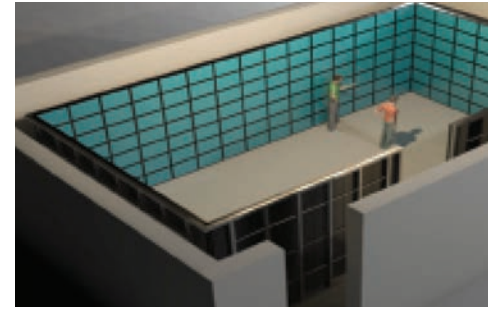

PIs: Arie Kaufman and
Klaus Mueller, SBU

We will devise an approximate but fairly accurate simulation framework to model heat, cooling, lighting and the like and show these profiles as a heat map on walls and floors of smart spaces. These maps could then be used for energy-aware room layouts, utilization and possibly also solar panel placement. We will further model the light and heat exposure from exterior sources such as the sun to augment the map. (IBM, NY)



RESEARCHER PROFILE

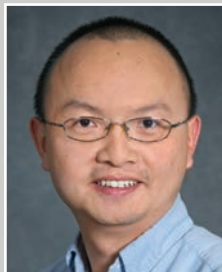

Gang He, Assistant Professor, Department of Technology and Society, Stony Brook University

Awards and Honors:

- Institute for New Economic Thinking Young Scholar 2013
- Aspen Environment Forum Scholar 2011
- Cynthia Helms Fellow, World Resources Institute, 2008
- Asia 21 Young Leaders, Asia Society, 2007

Energy Projects:
Clean power transition
Energy system modeling
Energy-X nexus

ENERGY GENERATORS AND CONVERTERS

Free Cooling of Data Centers

PIs: Tom Butcher, SBU and BNL,
Jon Longtin, William Worek, SBU



Modern data centers can contain hundreds or thousands of computer servers that produce considerable heat. These machines, however, can often be comfortably run with ambient room temperatures upwards of 90 to 100°F or more. At the same time, considerable electrical energy is consumed by maintaining the room at traditional temperatures of 68 to 72°F. This project is directed at implementing an evaporative cooler for data center cooling. By using evaporative cooling rather than traditional expansion cooling, HVAC energy loads can be reduced substantially

while still providing an adequate ambient environment for the computers within the data center. The project involves installing a modern, high-efficiency evaporative cooler on a data center in southern California, and then monitoring energy use compared to the traditional HVAC equipment currently installed. This project is led by Brookhaven National Laboratory, with Stony Brook University as a partner. (DOD ESTCP)



RESEARCHER PROFILE



Roman Samulak, Professor, Department of Applied Mathematics and Statistics, Stony Brook University, and Scientist, Computational Science Center, Brookhaven National Laboratories.

Research Interests:

Mathematical modeling and development of numerical algorithms for complex multiphase systems involving fluid dynamics, magnetohydrodynamics, relativistic particles and electromagnetic fields, and solid dynamics with fracture, and applications to supercomputer simulations of processes in particle accelerators, high energy density matter, and nuclear fusion and fission devices.

Energy Projects:
Modeling and Simulations
High Energy Physics and
Particle Accelerators
Nuclear Fusion
Fluid Dynamics and
Magnetohydrodynamics

Contiguous Platinum Monolayer Oxygen Reduction Electrocatalysts on High-Stability Low-Cost Supports

PI: Radoslav Adzic, BNL

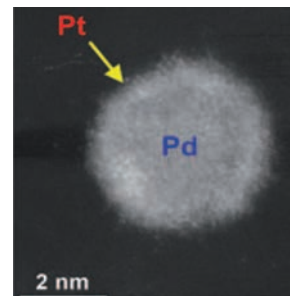

Platinum monolayer on palladium nanoparticle catalyst for oxygen reduction at fuel cell cathodes

The research program will focus on increasing activity and durability of the catalysts, reducing the PGM contents, and simplifying scale up syntheses. Pt monolayer deposited on nanoparticles of selected size, composition, structure and shapes including nanowires and nanorods containing very small or no PGM metals. New concepts and methodologies in designing core-shell catalysts will be studied. These include: 1) electrodeposition for catalyst syntheses to obtain several types of core shell catalysts including W-Ni alloys, yttrium and other refractory metals and 2) hetero-layered core structure, for tuning the effect of core on a Pt monolayer shell. The latter will be obtained from non-aqueous solvents, as well as underpotential deposition (UPD) of several reactive metal monolayers. Improving stability of cores will be accomplished using ordered intermetallics and nitrated non-noble metal cores. We will explore graphene oxide as support for a Pt monolayer or core nanoparticles. We will also address the Grand Challenge in Electrocatalysis, i.e. approaching with the hydrogen / oxygen fuel cells. 1.23V. (DOE)



ENERGY GENERATORS AND CONVERTERS

Ultraviolet Curing Assisted Additive Manufacturing for High-Efficiency Thermoelectric Devices

PIs: David Hwang, Maen Alkhader, Jon Longtin, SBU, Mark Driscoll, SUNY-ESF

Thermoelectric generators (TEGs) are an attractive means to produce electricity, particular from waste heat applications. Unfortunately, commercial TEGs are only available in flat, rigid formats, and of limited size often requiring manual assembly steps, increasing cost and defect rates. Furthermore, many engineering components are not flat (e.g. exhaust pipes).

The emphasis of current study is to develop concepts to fabricate TEG's directly onto engineering components using additive manufacturing. In addition to previous efforts based on laser-sintered ink dispensing to directly deposit thermoelectric materials onto arbitrarily shaped surfaces, in this project we attempt to solve a major manufacturing bottleneck by implementing ultraviolet curing strategy. This work

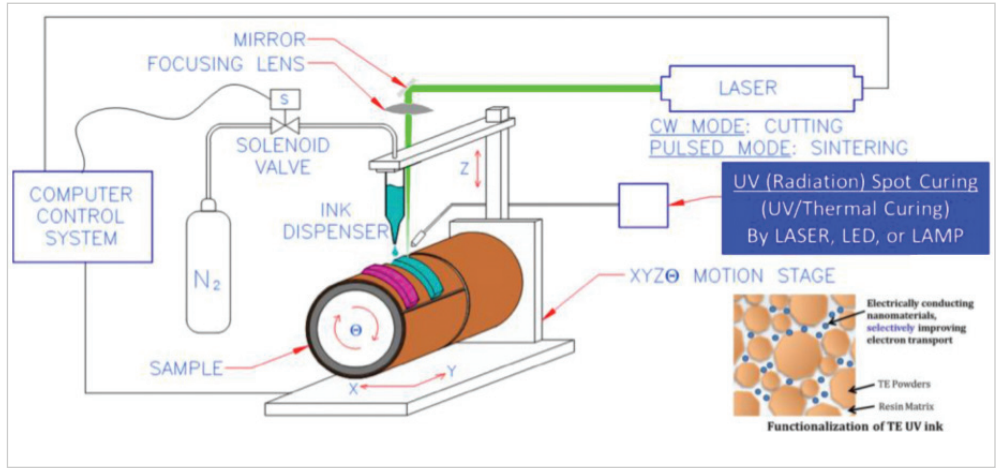

is also collaboration with UV/EB Curing Center at SUNY-ESF. (NYSERDA)



Publications:
D. Hwang, J.P. Longtin, *Hybrid Additive Manufacturing for High-Efficiency Thermoelectric Devices*, Presented in SUNY Center of Excellence Meeting in University of Albany (2014).
M. Tewolde et al. *Proceedings of the 1st Thermal and Fluid Engineering Summer Conference*: Vol. TFESC, Paper No. TFESC-12465 (2015).
M. Tewolde et al. *Journal of Thermal Spray Technology*, 25(3), pp.431–440 (2016).

Innovative Approach for Low-Cost High-Volume ThermoElectric Device Manufacture

PIs: Jon Longtin, and David Hwang, SBU

Vehicle transportation is responsible for 65% of the annual oil consumption in New York State, yet less than 30% of the fuel energy is converted into mechanical power in a vehicle, with the balance lost as waste heat. Significant progress has been made in the past ten years to recover vehicle waste for electricity production by using solid state thermoelectric (TE) devices, with 5–10% fuel savings reported. Despite the promise of thermoelectric materials, however, the high-volume manufacturing of TE devices represents a severe bottleneck for widespread adoption of such devices for commercial applications on vehicles and in industrial settings. In this project, we are developing concepts for an innovative manufacturing solution to overcome these technical bottlenecks and to develop marketable, cost-effective TE generators (TEGs) by directly fabricating the functional TE layers onto exhaust

pipes in a rapid, economical, and industrially scalable manner.

The approach is based on recent progress developed by our team at SBU to develop TEGs fabricated directly onto exhaust and waste-heat components. The technology is based on thermal spray and laser micromachining for non-equilibrium material synthesis of bulk materials (filled skutterudites and magnesium silicides), thermal spray direct write of thick films and laser micromachining for feature patterning to fabricate TEGs directly onto waste heat components. In contrast to traditional state-of-art TEG technologies based on prefabricated modules, our manufacturing process will eliminate epoxy binding and mechanical clamping and thus can significantly increase the durability of the TEG, while reducing manufacturing cost and energy use. Such direct-integrated

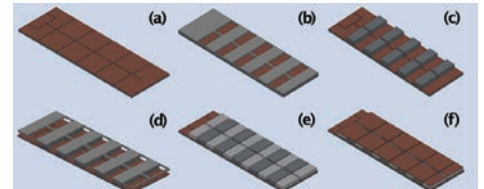

TEGs can also reduce the time of material synthesis and device processing from weeks to hours or less through its inherently scalable manufacturing process. Our developments can also be extended to other applications, such as electricity power plants (fossil and nuclear), diesel locomotive engines and ship engines. The project includes a series of inter-related manufacturing tasks that will be explored over a 12-month period. (NYSERDA)



ENERGY GENERATORS AND CONVERTERS

High Performance Supercapacitors Based on Carbon Nanomaterials

PI: Vladimir Samuilov, SBU

Supercapacitors exhibit great potential as high-performance energy sources for a large variety of potential applications, ranging from consumer electronics through wearable optoelectronics to hybrid electric vehicles. This research project focuses on carbon nanomaterials, especially carbon nanotube films, graphene oxide and 3-D graphene, due to their high specific surface area, excellent electrical and mechanical properties. We have developed a simple approach to lower the equivalent series resistance by fabricating electrodes of arbitrary thickness using a highly concentrated solution of carbon nanotubes and reduced graphene oxide based composites. Besides the problem of increasing the capacitance, the minimization of the loss tangent (dissipation factor) is marginal for the future development of the supercapacitors. This means

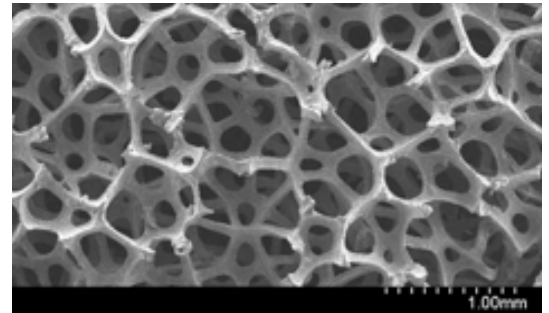
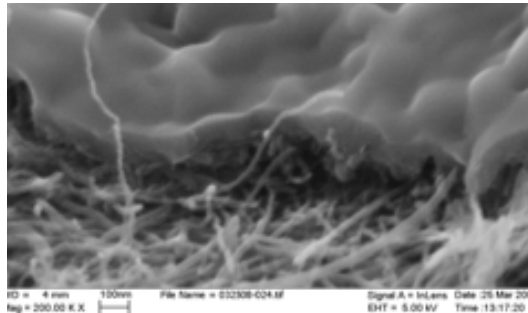

not only a very well developed surface area of the electrodes, but the role of the good quality of the porous separator and the electrolyte are very important. Our project addresses these factors as well. (SBU, BNL, Graphene Labs, Lomiko)



Creating Self-cleaning Air Purifying Surfaces for Urban and Energy Applications

PI: Alexander Orlov, SBU

Creating nanostructured surfaces, which can remain self-cleaning and air purifying, is now becoming a reality. In this project, which involves industrial collaboration with the NY based company, we work on testing performance of catalytic coatings, which can potentially transform urban environment by making it cleaner, more energy efficient. It can also improve public health by removing numerous air pollutants. In addition, it can also create self-cleaning solar cells, which has the potential to substantially improve their efficiencies. The coatings have already been applied on numerous buildings both in Europe and the US. (DOT)



ENERGY GENERATORS AND CONVERTERS

Structure and Function in Electrocatalysis of Reactions for Direct Energy Conversion

PI: Radoslav Adzic, BNL

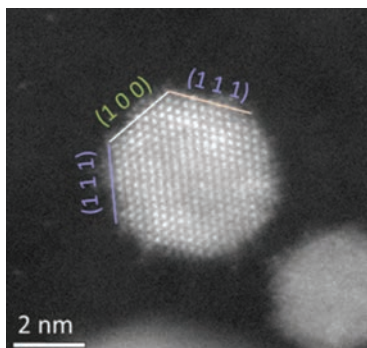

High resolution image of a platinum monolayer on faceted palladium nanoparticle catalyst for oxygen reduction at fuel cell cathodes

Our work will continue studies of platinum monolayer electrocatalysts, their electronic and structural properties to address the long-lasting challenge of shifting the reaction to potentials close to the thermodynamic reversible values. Selective adsorption of fluorinated chain molecules will be used to decrease the H_2O activity on Pt, increase the O_2 concentration and splitting the O-O bond ("dry cave" effect). Onion-structured nanoparticles with new cores of multiple metal layers can facilitate reaching this goal, as indicated by our DFT calculations. A broad study of enhanced kinetics and reaction mechanisms of the oxidation of alcohols (methanol, ethanol) on Pt monolayers under tensile strain will be intensified. Modifications of Pt surfaces will be studied to achieve CO_2 reduction beyond COH or CO species at Hads potential, which is 0.8 V smaller overpotential than that of other catalysts. Studies of ordering at the core-shell interface to increase stability and activity of electrocatalysts will be continued, as well as the design of the micro-reactor for electron microscopy studies of catalysts. Nitrating non-noble components of core-shell catalysts will be explored to increase their catalytic activity and stability. By kinetic modeling and computational methods, we will obtain deeper insight into the kinetics and mechanisms of the O_2 reduction reaction and alcohol oxidation. The success of this work will greatly contribute to resolving the major problems of electrocatalysis. (DOE)



Enhancing the Damage Tolerance of Plasma-facing Materials for Fusion Reactors

PI: Jason R. Trelewicz, SBU

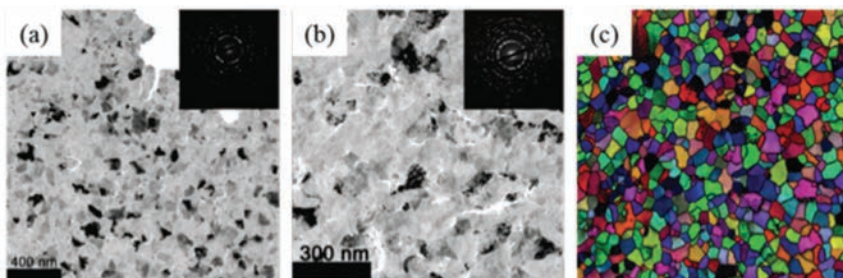

Nanocrystalline tungsten with a grain size of 75 nm in (a) its as-synthesized state and (b) irradiated using tungsten ions to a total dose of 10 displacements per atom. Defects can be observed within the grains as well as accumulating at the grain boundaries. Grain orientation maps such as shown in (c) for nanocrystalline tungsten are employed to study the effect of irradiation on grain orientation and structural stability.

Plasma-facing components (PFCs) for reactor scale fusion devices require materials to operate under far-from-equilibrium conditions of extreme temperature, radiation, and stress. While tungsten has emerged as a promising candidate due to its high melting temperature, exceptional strength at elevated temperatures, and good sputtering resistance, the realization of tungsten as a next-generation PFC material requires revolutionary advances in alloy design to limit irradiation-induced damage at high temperatures. One approach for enhancing radiation tolerance involves the refining of grain size to the nanometer regime. The resulting nanocrystalline structure is composed of a high density of grain boundaries, which limit the accumulation of irradiation damage by defect absorption at these boundaries; however, nanocrystalline grains are notoriously unstable at elevated temperatures, and their growth would eliminate the high density of available defect sink sites and corresponding damage tolerance. The objectives of this research are to elucidate the mechanisms of nanostructure

stability in tungsten alloys with evolving grain boundary structures, assess their implications for defect absorption, and engineer the solute distribution and grain size at the nanoscale to produce stable alloy states. Activities combine atomistic simulations with in situ irradiation exposure and nanomechanical testing of novel tungsten alloys to understand the mechanisms responsible for their stability, radiation tolerance, and deformation physics at the nanoscale. From this research, a new understanding of radiation effects in tungsten alloy nanostructures will be developed to markedly enhance their potential as advanced PFC materials and provide opportunities for their exploration in future reactor platforms. (BNL, NSF)



ENVIRONMENTAL SUSTAINABILITY

Off-Grid Renewable Power Production Using Wood Waste on Long Island

PIs: Devinder Mahajan, Benjamin Hsiao and Tae Jin Kim, SBU

According to the local utility PSEG Long Island, tree trimmings produce an estimated 364 cubic yards of wood daily, enough to produce 60MW of green power. This wood is currently being processed into mulch, transported off Long Island or otherwise disposed in a potentially unsustainable manner. The utility records also reflect that the last major windstorm to hit Long Island (Superstorm Sandy) produced approximately 40,000 cubic yards of wood debris (420,000 MW power equivalents) and left sections of Long Island without power for up to two weeks.

Those lucky enough to own a generator used diesel fuel to power them, which resulted in air emissions that polluted the region. The debris from Sandy was enough to power about 40,000 homes for an entire year, and the use of wood to produce energy could have resulted in reductions of 512,000 tonnes CO₂ eq. We thus consider wood waste on Long Island a low-hanging fruit for sustainable green power conversion. This vision compelled us to form a public-private-partnership that is led by Stony Brook University (SBU) in partnership with an industry consortium. Notables among the industry group are: PSEG LI, the local power distribution utility; Asplundh, a tree service contractor; Long Island Energy Infrastructure Development (LIEID). The heart of the proposal is a commercial mobile power pallet, dubbed PP20, available from All Power Labs (APL), a California company. We have initiated a study to explore the feasibility of this project on Long Island. (CIEES)



Laser-based High Efficiency Separation of Rare Earth Materials

PI: David J. Hwang, SBU

Rare-earth materials have strategic importance for the advanced devices in a variety of sectors including optoelectronic devices and electric/hybrid vehicles. Recently, extracting these elements from ores in a cost-effective and environmentally benign method become critically important due to bottleneck in its supply chain and has been recognized as national crisis in terms of high technology business and security. Laser processing can be the breakthrough to this end since laser beam is able to volatilize the material and/or introduce photochemical effects to increase both the yield and selectivity of separation and extraction processes. Since the laser separation method corresponds to solvent-free, dry process, it can bypass chemical use and waste disposal issues. Based on the preliminary evaluation of the technical feasibility by conducting parametric studies of a model material system using various processing parameters, current focus of the project is in demonstrating stable and high throughput processing towards pilot level system. (KITECH, Korea)



Publications:

K.T. Kang, J.Y. Hwang, D.J. Hwang, *Laser-based high efficiency separation of rare earth materials*, KITECH-US Industrial Technology R&D Collaboration Forum, US-Korea Conference on Science, Technology and Entrepreneurship, NJ, USA (2013).

Y.S. Rho, D. Hwang, K.T. Kang, *Laser ablation of rare earth material containing glass and investigation of stoichiometry change*, Submitted to Journal of Applied Physics (2014).

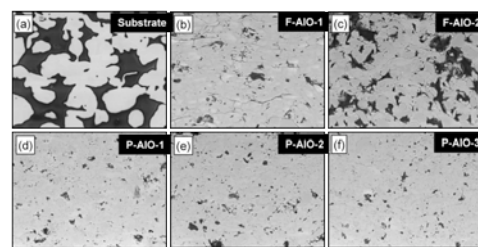

Cleaning Environmental Contamination by Utilizing Novel Membranes, Adsorbents and Catalysts

PI: Alexander Orlov, SBU

Understanding environmental impact of materials and using materials to minimize environmental impact are two important aspects of materials science to solve environmental challenges of this century. In this project we use several approaches in removing pollutants from gas and liquid phases. We create a new generation of porous materials to serve as adsorbent and catalysts support to eliminate various pollutants from environmental media. In addition, we work on new generation of ceramic membranes, which can filter out various dangerous contaminants from drinking and waste water. Finally, we work on using photocatalysts to transform hazardous materials into non-toxic ones. (NSF)



Publication:

S. Zhao, D. Su, J. Che, J. A. Orlov, *Photocatalytic properties of TiO₂ supported on SBA-15 mesoporous materials with large pores and short channels*, Materials Letters, 65, 3354-3357 (2011).

ENVIRONMENTAL SUSTAINABILITY

Design Optimization of Electric Buses for MTA New York City Fleets

PI: Sotirios Mamalis, SBU

In an effort to reduce petroleum consumption and gaseous emissions, MTA is interested in replacing current diesel and hybrid diesel-electric buses with electric ones. It is expected that by utilizing electric buses, MTA can reduce its carbon footprint as well as suppress operating and maintenance costs. Stony Brook University is partnering with Unique Technical Services LLC to provide to MTA optimized designs for different New York City routes. Electric bus design is based on data collection from existing buses, simulation and analysis, as well as prototype construction and testing. Optimal designs account for battery pack sizing, traction motor and drivetrain selection, and auxiliary systems use. (UTS, NYSERDA, MTA)

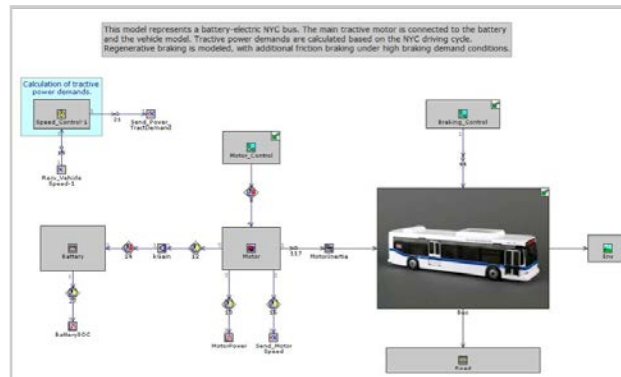
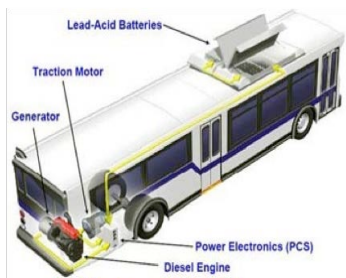

TiO₂ in Combination with Energy Saving Compact Fluorescent Light Bulbs Exposure May Cause Skin Cells Damage

PIs: Miriam Rafailovich, Tatsiana Mironava, Michael Hadjiargyrou and Marcia Simon, SBU

Compact fluorescent light (CFL) bulbs are gaining in popularity since they use less energy. However, CFL exposure was found to promote adverse skin conditions. The CFL bulb exposure and combination of CFL irradiation with TiO₂ nanoparticles, common ingredient of skin care products, has been investigated on human skin cells. The ultraviolet light outcome from the different CFL bulbs was measured and used for dermal fibroblasts and keratinocytes irradiation. Cells exposed to the CFL exhibited a decrease in the proliferation rates, collagen contraction ability and increase in migration and ROS. Selected nanoparticle dosage had no effect on cell function in the absence of CFL exposure whereas cells containing anatase died

after just a single CFL dose. Cells containing rutile were completely destroyed following a second dose. That indicates potential damage to skin tissue upon exposure to CFL lighting and that TiO₂ nanoparticles may exacerbate the damage. (NSF)

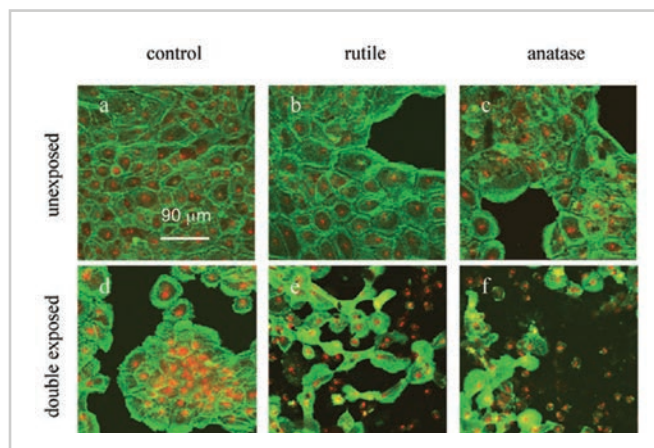

Confocal microscopy pictures of DO33 keratinocytes. Samples containing rutile and anatase TiO₂ and control (no TiO₂). Double exposure to CFL (d, e and f); no CFL exposure (a, b and c).

ENVIRONMENTAL SUSTAINABILITY

Developing a New Generation of Sustainable Polymer Nanocomposites for Energy and Consumer Applications While Addressing Consumer Safety Issues

PI: Alexander Orlov, SBU

Producing a new generation of polymer nanocomposite materials can revolutionize transportation and energy issues by delivering superior performance (mechanical, thermal and others) while reducing weight and environmental impact. However, there is also a concern from the consumer point of view about safety of nanomaterials. This research program addresses both aspects in a holistic way. Firstly, we develop new approaches in incorporating more sustainable nanomaterials into polymers to achieve an outstanding performance in various industrial applications. Secondly, we develop novel methods in studying stability and toxicity of encapsulated nanomaterials leading to better design strategies for nanocomposites. (NSF)



Publication:
J. Ging, R. Tejerina-Anton, G. Ramakrishnan, M. Nielsen, K. Murphy, J. Gorham, T. Nguyen, A. Orlov. *Development of a conceptual framework for evaluation of nanomaterials release from nanocomposites: environmental and toxicological implications.* Science of Total Environment, 473-474, 9-19, (2014).

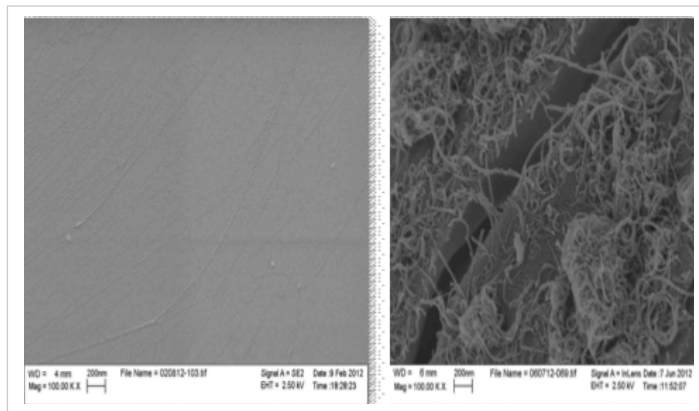

Research Experience for Undergraduates (REU) site in 'Nanotechnology for Energy, Health and the Environment'

PI: Gary Halada, SBU

To truly understand interaction between the environment (outdoors, under extreme industrial conditions, or within the human body) and natural and human-made materials, it is essential to understand reactions at the nanoscale. It is at this level, from single molecules to ultrathin films on surfaces, that structural and chemical transformations first occur which affect critical environmental processes, such as corrosion of advanced printed alloys, association of hazardous waste with soil or buildings, and attachment and growth of cells. Likewise, by exploring the electron transfer processes which occur at the surface of catalytic nanoparticles and the nature of the association of organic molecules with the surface of nanoparticles we can design new, safe and inexpensive processes for forming nanomaterials for energy and biomedical applications. To accomplish these goals, we build interdisciplinary partnerships within the University, with other colleges and research groups, with industry and with Brookhaven National Laboratory. Our REU site, which began in 2011, has so far supported over 80 undergraduates from over 40 colleges, including many community colleges and colleges with large underrepresented populations. Inclusion and accomplishment are benchmarks of the program -- more than 50% of our participants have been female, and more

than 25% of our participants have been from underrepresented minority groups. These students have gone on to graduate study at prestigious institutions, high tech jobs in a number of industries, or become medical professionals and business leaders. By creating these undergraduate opportunities, we hope to help build a research community and workforce to apply nanoscale technologies in energy and other critical areas. www.stonybrook.edu/nanotech (NSF)

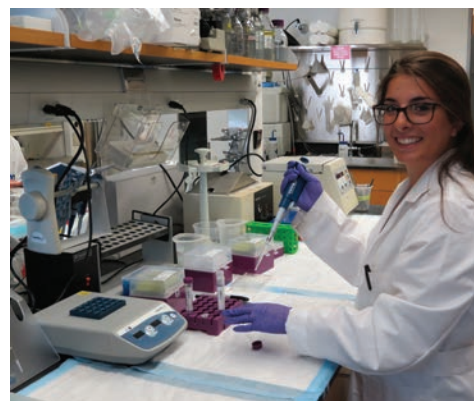
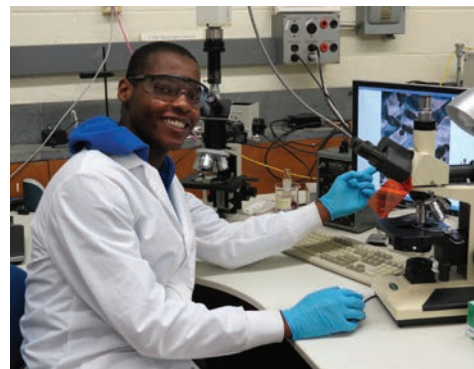

A Robust Solar Powered Membrane Distillation System for Drinking Water

PI: Sam Aronson, SBU

CIEES is developing a combined wind-solar powered system for membrane-based water filtration facility in rural Africa. The system will also feature a robust energy storage that will provide power when the renewable sources are not generating. Currently, the membrane-based filtration systems rely on gravity to transport water through the membrane. A gravity fed filtration is too slow to provide an adequate supply of drinking water. The CIEES system will feature an electric pump which will enhance the drinking water of 10. The development will focus on enhancing reliability and robustness of the installation. A local producer of high capacity storage systems is discussing under an NDA a partnership with CIEES evaluate and provide suitable battery technology for this application. A 2 KW wind turbine, supplied by an outside vendor, will be tested with the battery pack. The filtration system is expected to be installed in early 2017. (Local integrated storage company under NDA, CIEES, NYSERDA)

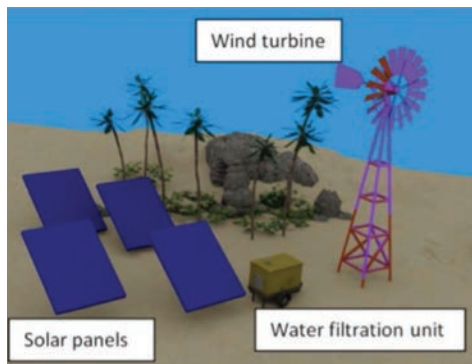

Environmental Fate of Pollutants

PI: Alexander Orlov, SBU

The nature of contaminant interactions with mineral surfaces is of primary importance for understanding the fate of those contaminants in the environment. It is also of critical importance for designing the technically feasible remediation strategies, which will protect environmental quality and human health. Our research includes studies of interactions of environmental pollutants, such as chlorinated hydrocarbons, with mineral surfaces using a range of spectroscopic techniques, such as XPS, DRIFTS, Raman and IR spectroscopy, synchrotron based NEXAFS and others. These techniques can provide valuable information on molecular structure and chemical properties of contaminant interactions with environmental interfaces. We are also interested in studying the interactions of combustion related pollutants, such as SO₂ and NO₂ with naturally occurring or anthropogenically produced mineral aerosols. The interactions of SO₂, NO₂ and mineral surfaces are the emerging issue in the prediction of air quality in newly-developed industrial nations, particularly China where dust concentrations often exceed 150 lg/m³. The formation of sulfates and nitrates on particulates is also central to quantification of the radiative impact of these emissions. (NSF)



Publications:

R. J. Gustafsson, A. Orlov, P. T. Griffiths, R. A. Cox, R. M. Lambert. *Reduction of NO_x to nitrous acid on illuminated titanium dioxide aerosol surfaces: implications for photocatalysis and atmospheric chemistry*. Chemical Communications, 37, 3936-3938 (2006).
A. Orlov, D. Watson, F. Williams, M. Tihov, R. M. Lambert. *Interactions of 4-chlorophenol with TiO₂ polycrystalline surfaces: study of environmental interfaces by NEXAFS, XPS and UPS*. Langmuir, 23, 9551-9554 (2007).

RESEARCHER PROFILE



Alexander Orlov, Associate Professor, Materials Science and Chemical Engineering Department, Consortium for Inter-Disciplinary Environmental Research. Affiliate Professor, Chemistry Department, Institute for Advanced Computational Science, Advanced Energy Center, Department of Technology and Society.

Awards and Honors:

- American Institute of Chemical Engineers Sustainable Engineering Forum Education Award, 2018
- American Chemical Society Award for Incorporating Sustainability into Chemistry Education, 2017
- Chancellor's Award of Excellence in Scholarship and Creative Activities from State University of New York, 2016
- EU (the European Council of Academies) - US (National Academy of Engineering) Frontiers of Engineering, 2016
- Sigma Xi Distinguished Lectureship, 2015
- US National Academy of Engineering Frontiers of Engineering Education, 2015
- US National Academy of Science Kavli Fellow, 2014

Energy Projects:
Sustainable Hydrogen Production
Clean Fuel Production
Sustainable Polymer Nanocomposites
Ceramic Membranes

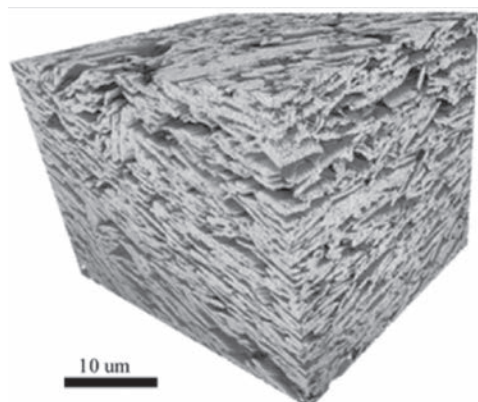

Multi-Scale Assessment of the Thermo-Mechanical Behavior of Saturated Clays Subjected to Freeze-Heat Cycles

PI: Sherif Abdelaziz, SBU

The interest to understand and predict the thermo-hydro-mechanical behavior of earth surface materials is increasing nowadays. This is because of various innovation ground-related energy and environmental techniques including, for example, the utilization of geothermal energy to generate electricity or for space heating and cooling, CO₂ sequestration, nuclear waste disposal, and shale-gas extraction. Additionally, extreme weather conditions, caused by climate change, induce unexpected temperature changes in the ground causing unprecedented deteriorations in the national infrastructure. Existing studies about the behavior of earth surface materials under thermo-mechanical loads focused on one of the two temperature extremes, i.e. elevated temperatures only or freezing temperatures only. Surprisingly, the thermo-mechanical behavior of clays at elevated temperatures was found to be identical to that at freezing temperatures despite the opposing thermal paths. The main goals of this program are to, first, identify the reasons behind these similar clay behaviors at the two extreme temperature paths and, secondly, develop more accurate models to predict the thermo-mechanical behavior of clays subjected to different thermal paths. (USARO)



The Effect of Aerosol Particles Emitted by Biomass Burning on Air Quality

PI: Daniel A. Knopf, SBU

Biomass burning represents a major source of particulate and gas-phase species to the atmosphere, with particle emission rates comparable to fossil-fuel burning. The emission types of biomass burning are diverse and include anthropogenic and natural sources including energy production, heating and cooking, agriculture, and wild fires. These biomass burning aerosol (BBA) particles impact local and regional air quality and have climatic impacts when interacting with cloud formation. To assess the role of BBA particles in the atmosphere, their chemical evolution during transport and their ability to form clouds have to be determined.

Our studies focus on the physicochemical modification of BBA particles when exposed to atmospheric oxidants and radicals and on the particles' affinity to take up water to initiate cloud formation. In the laboratory we measure the reaction kinetics between organic BBA particles and gas-phase oxidants applying unique mass spectrometer-based analytical techniques. In collaboration with colleagues at Brookhaven National Labs, we determine the ability of BBA particles to take up water under relevant cloud formation conditions. Furthermore, BBA particles can be ejected to high altitudes where temperatures are conducive for the formation of ice clouds. At SBU, we apply custom-built ice nucleation apparatus coupled to microscopes to determine the thermodynamic conditions under which BBA particles form ice and corresponding ice nucleation rates. These studies aim to improve our predictive capability of how BBA particles chemically evolve in the atmosphere with subsequent impacts on air quality and if these particles have a major effect on cloud formation and thus, climate. (NOAA, DOE, NSF)

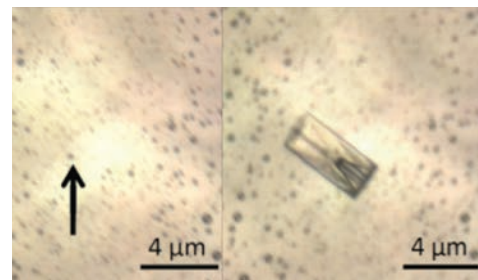

Microscopic examination of ice formation by aerosol particles. An organic aerosol particle (arrow – left panel) among thousands of other particles deposited on a special substrate, initiates ice crystal formation (right panel) at temperatures below -40 °C.

Publications:
 D.A. Knopf, Y. J. Rigg, *Homogeneous Ice Nucleation From Aqueous Inorganic Organic Particles Representative of Biomass Burning: Water Activity, Freezing Temperatures, Nucleation Rates*, *J. Phys. Chem. A*, 115, 762–773 (2011).
 D.A. Knopf, S.M. Forrester, J.H. Slade, *Heterogeneous oxidation kinetics of organic biomass burning aerosol surrogates by O₃, NO₂, N₂O₂, and NO₃*, *Phys. Chem. Chem. Phys.*, 13, 21050–21062 (2011).
 S.M. Forrester, D.A. Knopf, *Photosensitized heterogeneous oxidation kinetics of biomass burning aerosol surrogates by ozone using an irradiated rectangular channel flow reactor*, *Atmos. Chem. Phys.*, 13, 6507–6522 (2013).
 Y.J. Rigg, P.A. Alpert, D.A. Knopf, *Immersion freezing of water and aqueous ammonium sulphate droplets initiated by Humic Like Substances as a function of water activity*, *Atmos. Chem. Phys.*, 13, 6603–6622 (2013).
 J.H. Slade, D.A. Knopf, *Multiphase OH oxidation kinetics of organic aerosol: The role of particle phase state and relative humidity*, *Geophys. Res. Lett.*, 41, 5297–5306 (2014).
 J.H. Slade, R. Thalman, J. Wang, D.A. Knopf, *Chemical aging of single and multicomponent biomass burning aerosol surrogate particles by OH: implications for cloud condensation nucleus activity*, *Atmos. Chem. Phys.*, 15, 10183–10201 (2015).

ENVIRONMENTAL SUSTAINABILITY

EcoPartnerships- Landfill Gas Usage Strategies

PIs: Devinder Mahajan, David Tonjes and Tae Jin Kim, SBU

The SBU-Tongji project is one of the 18 projects under the U.S.-China EcoPartnership program as part of the Strategic and Economic Dialog (S&ED). The partnership is implemented by the U.S. Department of State and National Development Reform Commission, China. The project focus is to find ways to monitor, harvest and mon-

etize methane from landfills, wastewater treatment plants and other sources. The project is also looking at ways to convert captured methane into transportation fuels: dimethyl ether (DME), a diesel substitute and gasoline. Recently, Tongji has developed a modified model to calculate fugitive methane while SBU is focused

on pathways to transportation fuels. One technology to remove H₂S is being targeted for scale-up.



Waste Management and Innovation

PI: David J. Tonjes, SBU

We provide technical and scientific advisement and data management to the Town of Brookhaven (LI, NY) waste management program for it to progress in a more sustainable direction. We work on technology assessments, understanding underlying waste processes, and assessing impacts from potential future, currently operating, and legacy facilities. The Town of Brookhaven Department of Recycling and Sustainable Materials Management has funded these efforts since 2009 through a series of annual grants.

The work has included: sorting wastes and analyzing collection data to infer changes that occurred due to the adoption of single stream recycling; analyzing the impact of degradable plastics on solid waste management systems; collecting groundwater data and geological information to parameterize a site-specific groundwater transport model and determine interannual differences in the state of the aquifer system; describing impacts on groundwater systems due to large-scale compost sites; defining food waste processes and management potentials; investigating the mechanisms and rates that lead to the generation of solid waste, and the changes in solid waste composition that have occurred and continue to occur, and how those changes may affect alternative waste management facilities; modeling the processes that control the generation of a renewable fuel source, landfill gas; and working to create a pilot implementation



of a catalytic sulfur removal system for landfill gas recovery systems. (Brookhaven)



Publications:
K.L. Thyberg, D.J. Tonjes. *The environmental impacts of alternative food waste treatment technologies in the US*. Journal of Cleaner Production 158:101-108. DOI 10.1016/j.jclepro.2017.04.169 (2017).
O. Aphale, D.J. Tonjes. *Multi-model validation assessment of groundwater flow simulation models using area metric approach*. Groundwater 55(2):219-226. DOI 10.1111/gwat.12470 (2017).
L. Clark, D.J. Tonjes, D. Mahajan. *Improving custom landfill gas modeling at a multi-phase landfill*. Poster. Canadian Waste-to-Resource Conference, Niagara Falls, Ontario, Canada, NY. October 24 (2017).

Off-Grid Power Production in Kenya Using Local Waste Materials

PIs: Devinder Mahajan, SBU; Professor Kin Kinyua, JKUAT; J. Hasty APL; L. Martin and A. Leakey, Turkana Basin Institute (TBI).

The northwest Kenya is home to Turkana Basin Institute that operates on off-grid power. We are focused to operate an off-grid 20 kW gasifier that could provide power for the institute. As the first step to demonstrate that the gasifier could use local waste as feedstocks- doum nuts, a waste from palm trees and prosopis, an invasive species spread throughout Kenya. APL delivered the 20 kW gasifier at Jomo Kenyatta University of Agriculture and Technology (JKUAT). The unit will be commissioned at JKUAT by APL shortly. The next step is to test various feedstocks. We are now considering a partnership with the UN Institute of Environmental and Sustainable Development (IESD), Shanghai, China who would also provide funding to expand the scope of the project at JKUAT.



Virtual Wind Simulator with Advanced Control and Aeroelastic Model for Optimizing Land-Based and Offshore Wind Farms

PIs: Fotis Sotiropoulos, Xiaolei Yang, SBU

Wind energy, yielding reduced carbon emissions, improved air quality and reduced water consumption by offsetting the use of fossil energy, has become a key player in the global energy markets. Wind turbines are often grouped into wind farms. In wind farms, wind turbines interact with each other through turbine wakes. The power loss due to turbine wakes is around 20% but can be as high as 80% for some scenarios. The wakes from upwind turbines also increase the dynamic loads of downwind turbines, and thus increase the maintenance cost. Therefore, understanding the mechanism of turbine wakes is critical for reducing the cost and increasing the competitiveness of wind energy. The objective of this project is to develop an advanced high-fidelity computational fluid dynamics tool with turbine control and aeroelastic models for simulating turbine wakes in utility-scale large wind farms under site-specific wind and terrain conditions. The computer code, referred to as the Virtual Wind Simulator (VFS-Wind), can simulate complex atmospheric turbulence over real-life terrestrial, coastal and ocean environments using cutting edge models for parameterizing the wind turbines that can account for the flow structures generated both by the blades and the turbine nacelle. The code can also simulate broad-band ocean waves and 6-degree-of-freedom motion of floating platforms for offshore turbines. VFS-Wind is used extensively by industry to tackle and solve real-life problems at utility scale. Recent applications include the simulation of the Horns-Rev wind farm in Denmark, the Pleasant Valley wind farm in Minnesota owned by XCEL Energy, and the Vantage wind farm in the Washington state owned by Invenery. VFS-Wind is the first code to be validated at utility scale by comparing actual wind farm operational data with numerical simulations.

Publications:

X. Yang, M. Pakula, F. Sotiropoulos. *Large-eddy simulation of a utility-scale wind farm in complex terrain*. Applied energy, 229, 767-777 (2018).
 D. Foti, X. Yang, F. Campagnolo, D. Maniaci, F. Sotiropoulos. *Wake meandering of a model wind turbine operating in two different regimes*. Physical Review Fluids, 3(5), 054607 (2018).
 D. Foti, X. Yang, X., F. Sotiropoulos. *Similarity of wake meandering for different wind turbine designs for different scales*. Journal of Fluid Mechanics, 842, 5-25 (2018).
 X. Yang, F. Sotiropoulos. *A new class of actuator surface models for wind turbines*. Wind Energy, 21(5), 285-302 (2018).

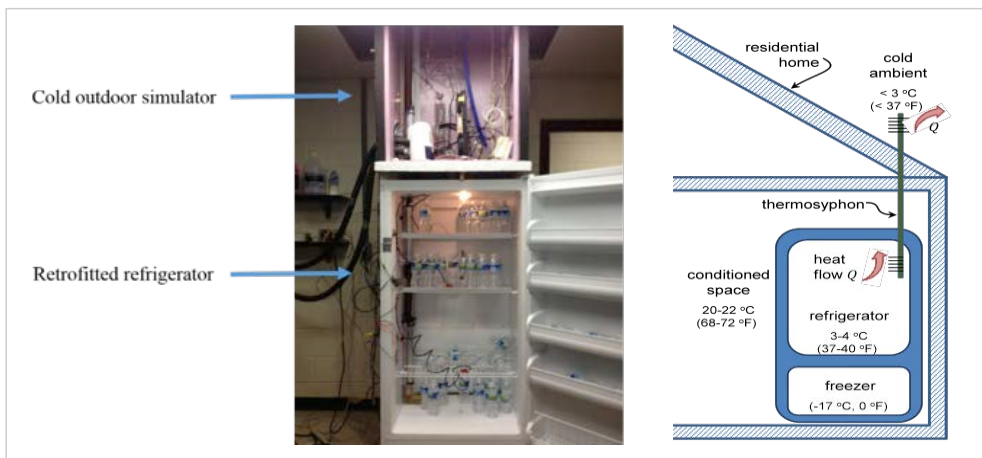

High Efficient Refrigerator Using Cool Outside Temperatures

PI: Jon Longtin, SBU

U.S. households consume >150 billion (B) kWh of electricity per year for residential refrigerators. In many parts of the U.S., however, the outside temperature falls below the 37–40 oF refrigerated-space temperature for several months out of the year, particularly in the northern half of the country. A natural choice is to use the low outside temperatures for cooling to reduce electricity usage for residential refrigerators. This project uses thermosyphons to provide a low-resistance heat transfer path from the refrigerated space to the cold outside. A thermosyphon is simple in construct and design, consisting of a hollow tube that has been evacuated and filled with a working fluid. The tube is oriented vertically and heat is added at the bottom of the device in the evaporator, vaporizing the working fluid and causing it to rise to the top of the device. Heat is removed in the condenser at the top of the device, causing the vapor to condense onto the pipe wall. The liquid flows back down the sides to the evaporator by gravity. The thermosyphon has several key features that make it ideally suited for improving residential and commercial refrigeration applications:

- Minimal temperature difference: since the device uses the latent heat of phase change, significant heat flows can occur with a very small temperature difference (3-4 oF) across the device, making it behave much like a thermal superconductor.
- Heat transfer in one direction only: the thermosyphon is the thermal equivalent of an electrical diode or fluid check valve. Heat only flows when the bottom region of the device is hotter than the top, due to the fact that there is no working fluid under normal conditions in the top of the device. Thus, when the outside temperature is warmer than the refrigerator space, the device simply stops working; heat will not flow back into the refrigerated space. No other control is needed.

A testbed is now being developed to test a residential refrigerator unit with a simulated cold-climate ambient. (DOE MaxTech, BNL Seed Grant, USB)



RENEWABLE ENERGY

Development of a Cost Effective Method for Wind Turbine Maintenance

PIs: Nikhil Gupta and Yi Yang, NYU

The cost of repair and maintenance of wind-turbine blades, including time down and replacement, can cost upwards of \$300,000. LazarOn, a cost effective means of performing wind-turbine blade diagnostics, requires neither hazardous man-hours or turbine downtime. The innovative, patented system employs a loop of thin fiber-optic cable deployed to each turbine blade. The cable is also connected to a fixed-wave laser, and extensometer and photodetector combination to measure the vibration signature of a rotating or vibrating blade. Because a shift in those signatures could indicate a crack in progress, the system lets owners spot problems in real time, during normal operation, obviating the dangerous and expensive process of shutting down the turbine for inspection by eye. LazarOn, already with

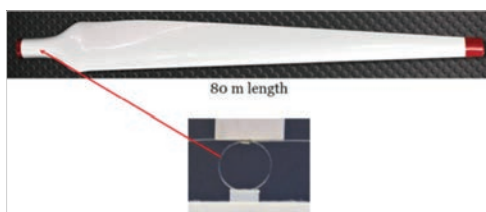

The LazarOn sensing element, 0.25-mm diameter fiber optic cable in a 6-mm loop, is easily mounted near a blade in the turbine hub or inside the root so it need not disrupt airflow as would other proposed blade sensors.

two patents, won \$150,000 for further development in New York's PowerBridge competition. (NSF)



Photocatalysis for Solar Fuel Generation

PIs: Peter Khalifah and Mike White, SBU and BNL

We are at the center of a thrust to develop materials that can harness the sun's energy for the efficient production of hydrogen fuel via solar water splitting ($2\text{H}_2\text{O} + \text{light} \rightarrow 2\text{H}_2 + \text{O}_2$). The pressing challenge is to use visible light efficiently (>50% of terrestrial solar energy) to drive this photoelectrolysis reaction. Random material searches have resulted in the discovery of a handful of promising materials, which can utilize visible light to split water, but with very low overall efficiencies. Higher efficiencies can only be achieved with better materials and a better understanding of light-driven water splitting mechanisms. A joint SBU-BNL team has been assembled to tackle these challenges comprehensively. Prof. Khalifah will coordinate the effort to synthesize perfect surfaces (crystals and thin films) of complex oxide-based materials, while Prof. White will coordinate studies of the molecular reactions that occur at these surfaces. The synthesis efforts will integrate Stony Brook's J. Parise (Geosciences), A. Oganov (Geosciences) and M. Dawber (Physics) together with BNL researchers J.

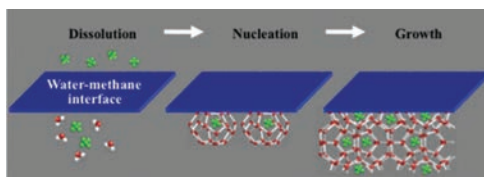

Rodriguez (Chemistry), I. Bozovic (CMPMS), G. Gu (CMPMS), and W. Han (CFN). Characterization efforts at SBU will include A. Orlov (MSE), M. Fernandez-Serra (Physics), P. Stephens (Physics) and Lars Ehm (Geosciences/NSLS) while those at BNL revolve around the efforts of E. Fujita (Chemistry), S. Lymer (Chemistry), J. Muckerman (Chemistry), M. Newton (Chemistry), and M. Hybertsen (CFN). With these high quality samples and these detailed characterization efforts, it will be possible to achieve a more fundamental understanding of the relationship between the optical and transport properties of the bulk material and the effectiveness of water splitting reactions at its surface. (BNL)



Catalysis for the Generation of Fuels

PIs: Mike White, SBU and BNL and Jose Rodriguez, BNL

We have been working on aspects of fuel generation for the hydrogen economy. A key step in the production of hydrogen involves the use of steam to convert carbon monoxide obtained from natural gas or biomass into hydrogen and carbon dioxide by a catalytic process known as the water-gas-shift (WGS) reaction. The WGS process is energy intensive and Rodriguez and White are investigating novel materials that have high catalytic activity at reaction temperatures lower than that possible with today's best commercial catalysts. The new catalysts are composed of small metallic nanoparticles (Au or Cu) supported on a reducible metal oxide (CeO_2 , TiO_2) with each component playing a unique but synergistic role in the WGS process. Work performed at BNL has shown that the active phase of these materials corresponds to metallic Au or Cu and not the metal oxides as previously proposed. The use of ceria (CeO_2) was also shown to yield the most active WGS catalysts, which is partly due to the ease in which oxygen atoms can be removed from the surface of the catalyst. Continuing studies are focused on understanding more about the influence of particle size and reaction conditions on catalyst activity, the unusual activity of Au nanoparticles and the development of an atomic scale mechanism for the WGS reaction process. (BNL)



RENEWABLE ENERGY

Economics and Economic Impacts of Offshore Wind Energy in Long Island

PI: Guodong Sun, SBU

Long Island is one of the regions with the highest energy costs. It is also close to several offshore wind sites with enormous potentials. They can bring major benefits to Long Island. New York Energy Policy Institute (NYEPI) conducts two assessments of offshore wind power in these contexts on Long Island. The first assessment is to evaluate the cost effectiveness of offshore wind power for Long Island's ratepayers relative to that of other new sources of energy. The second assessment is to quantify the economic development benefits for Long Island associated with offshore wind. (Deepwater Wind)



Analysis and Design of Heat Exchangers for a Vuilleumier Natural-Gas Driven Heat Pump

PI: Jon Longtin, SBU

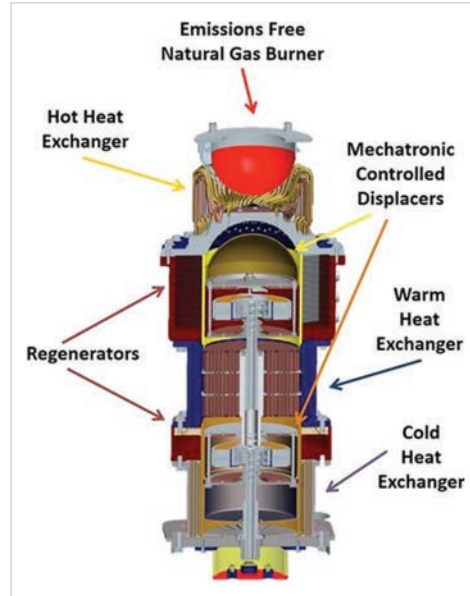

Heat pumps represent an attractive means for residential heating. By moving heat from outside to inside the house, rather than producing heat directly by burning a fuel, heat pumps can result in significant energy costs. This project focuses on the design and analysis of heat-driven heat pump based on the Vuilleumier thermodynamic cycle. The device is driven by natural gas, oil or propane for residential home heating. The device can deliver 160% or more of the fuel consumed as heat to the home, in contrast to even the most efficient traditional heating systems that have a maximum value of 95%. This project focuses on the design of the heat exchangers for a next-generation Vuilleumier heat pump, as well as modeling the overall thermal and mechanical device operation. (DOE/NYSERDA/ThermoLift)

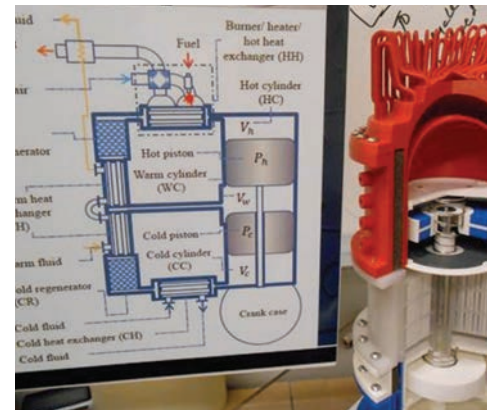

RENEWABLE ENERGY

Forced Flow Convective Baseboard for High Efficiency Energy Delivery

PIs: Tom Butcher, SBU and BNL,
Jon Longtin, SBU

This research project explores the feasibility of integrating a forced-air supply for common baseboard radiators to dramatically improve their performance when supplied with low-temperature water. This offers the potential to improve the annual efficiency of condensing boilers, solar thermal systems and hydronic heat pumps. While some concepts for fan-assisted radiators have been identified, they are expensive and noisy. This concept will allow market introduction of a low-cost product by program partner Slant/Fin Corp., the largest residential baseboard manufacturer in the U.S. The design envisioned involves a small air flow that injects air upward into the bottom section of a baseboard, inducing a larger flow of room air through the baseboard fins. The concept can be compared with some chilled beam designs and is also used in the popular Dyson bladeless fans that recently

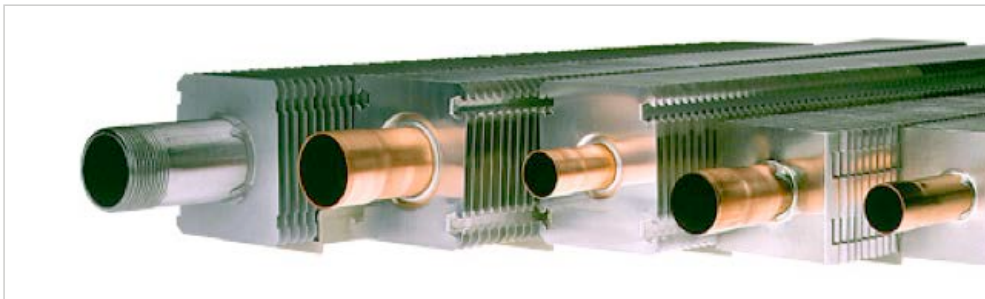

came onto the market. The primary focus is on a new product, but the application to retrofit to existing baseboard will also be explored. The intended use is for heating but exploratory studies tests are planned to evaluate the technology for cooling applications as well. Minimum fan power requirements will be identified and the potential for self-powering with heat from

the hydronic loop will be explored in this research project. Project partners include Brookhaven National Laboratory (program lead) and Slant/Fin, Inc. (NYSERDA)



RESEARCHER PROFILE



Jon P. Longtin, Professor, Department of Mechanical Engineering and Visiting Scientist, Brookhaven National Laboratory

Awards and Honors:

- Licensed Professional Engineer in New York State (2012)
- Brookhaven Inventors Award for U.S. Patents (2010; 2011)
- D 100 Award for technology developed at Stony Brook (2007)
- Licensed Innovation Award for technology licensed by a company (2005)
- Excellence in Teaching Award, Stony Brook University (1998, 2017)
- NSF Presidential Early Career Award for Scientists and Engineers (PECASE) (1997)
- 11 issued and pending patents, 3 licensed

Energy Projects:
High-Performance Cold-Climate Heat Pumps
Advanced Power Plant Cooling
Laser-based Free-Space Optics for High-Speed Data
High-Efficiency Fuel Cells
Novel Sensing, Diagnostics, and Data Analysis

Pathways to Greening Power and Transportation Sectors

PI: Devinder Mahajan, SBU

I-GIT has teamed up with the Center for Sustainable Energy (CSE)-San Diego to focus on Renewable Natural Gas (RNG) production. Two demonstration projects are being developed:

- 1) use of wood waste for off-grid power production (20kW - 150kW) and
- 2) storing surplus electricity from renewable sources such as solar and off-shore wind as hydrogen by electrolysis.

The team is reviewing various options to site these projects on Long Island. (CSE-CIEES)



RENEWABLE ENERGY

Laser-assisted Manufacturing of Multiscale Super-Insulation Material

PI: David J. Hwang, SBU

As one route towards energy-efficiency and zero emissions in the building sector, development of super insulating materials is an important task. Nano insulation materials have been accepted as the most promising candidate due to both fundamental merits for insulation (e.g. nano-contact interfaces, intrinsic vacuum effect) and practical advantages for manufacturing to use as building materials.

Current study is focused on developing a new technology to realize multi-scale micro/nano scale composite structures assisted by laser-assisted manufacturing techniques ranging from production of unit insulating particles to improvement of mechanical connectivity for enhanced structural robustness and life time while maintaining air level thermal conductivity. (Korea Agency

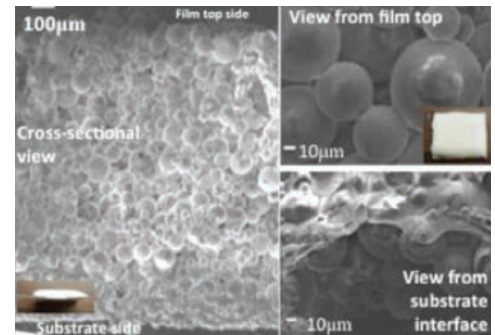
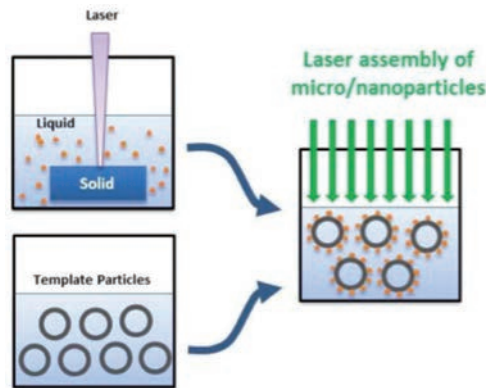

for Infrastructure Technology Advancement in collaboration with Seoul National University in Korea)



Publications:
M.T. Lee, D.J. Hwang, et al. *International Journal of Hydrogen Energy*, 34(4), 1835-1843 (2009).
D.J. Hwang et al. *Materials Today Proceedings*: 3, pp. 335-339 (2015).
T. Zhang, M. Tewolde, J.P. Longtin, D.J. Hwang, *SPIE*, Paper Number 9735-42 (2016).

Laser-assisted Chemical Vapor Deposition of Passivation Layers for Organic Devices

PI: David J. Hwang, SBU

Organic electronic devices must be protected from water and moisture, which can react with both organic and inorganic active layers and degrade performance. Traditional thin passivation layer deposition techniques are still suffering from excessive deposition temperature or unwanted damage in the underlying organic layers. Another alternative, the atomic layer deposition, allows the lower temperature, but it is not suitable due to extremely low deposition rate.

We attempt to address the aforementioned limitation of conventional passivation techniques by developing a new laser-assisted chemical vapor deposition technology by decomposing precursor gas molecules with high selectivity, strictly avoiding disturbance of the sensitive organic devices. (KEIT, Electronic Display Industrial Research Association of Korea)

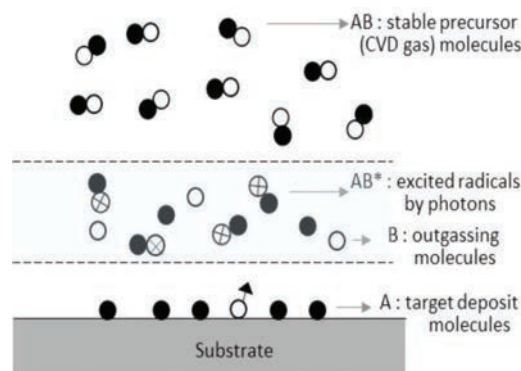

Publications:
D.J. Hwang, S.G. Ryu, C.P. Grigoropoulos, *Nanotechnology*, 22, 385303 (2011).
D.J. Hwang, S.G. Ryu, E.P. Kim, C.P. Grigoropoulos, C. Carraro, *Applied Physics Letters*, 99, 123109 (2011).

T. Zhang, S.K. Kuk, E. Kim et al. *SPIE* Paper Number 9735-34 (2016).
S.K. Kuk, J.M. Park et al. *Nanoscience and Nanotechnology Letters*, in-press (2016).

PHOTOVOLTAIC AND FUEL CELLS

Laser-assisted Photovoltaic Manufacturing and Diagnostics

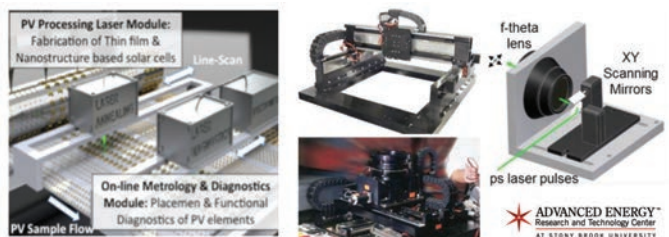

PI: David J. Hwang, SBU

Practical challenge in utilizing renewable solar energy is reducing the cost per watt and simultaneously improving conversion efficiency to compete with current fossil fuel technology. Our research has been focused on the development of laser-assisted current & next generation photovoltaic (PV) manufacturing and diagnostics technologies. Examples include back contact formation and edge isolation for bulk based PV's, advanced laser scribing and spectroscopic in-situ thickness monitoring for thin film based PV's and building integrated PV's, surface treatment of stainless steel substrate for cost-effective and flexible PV's, and direct synthesis of multi-bandgap nanomaterials of superior crystallinity and nanoscale surface structuring to achieve improved light trapping and photocurrent conversion efficiency for nanostructure based PV's and low-cost solid state lighting devices. Enhanced laser-induced field in nanostructures provides great selectivity in functionalizing arbitrary nanomaterials system and forming heterostructures in conjunction with the cost-effective scalable PV nanomanufacturing system development. The advanced diagnostics on light interaction with various PV elements have been demonstrated through the near-field scanning optical microscopy (NSOM) technology and electron microscopes (SEM/TEM) coupled with pulsed laser illumination, offering nanometric/atomic spatial and sub-ps temporal resolutions. The laser-assisted manufacturing and diagnostics systems existing in Solar PV Laboratory, AERTC are compatible with wide range of PV and display systems at production compatible scale. (Yuco Optics and Yuco Photonics in NY State, Appliflex Inc, University of Utah, Posteel in Korea, Yeungnam University in Korea, Korea Institute of Science and Technology, Tokyo Institute of Technology)¹



Development of Laser Scribing Technology for High Efficiency Building Integrated Thin-Film Solar Modules

PI: David J. Hwang, SBU

Research goal of this project is to provide a viable inter-cell connection solution based on precise and cost-effective nanosecond laser scribing technology, and also develop highly efficient building integrated photovoltaic solar cell (BIPV) manufacturing technology based on CIGS thin film materials. Key tasks include optimization of nanosecond laser scribing parameters in conjunction with tuning of thin film material systems, and process optimization towards superior module aperture areal efficiency and PV efficiency approaching performance of costly state-of-the-art process. (Korea Institute of Science and Technology)



Publications:
 T.W. Kim, D.J. Hwang et al., *Comparison of multilayer laser scribing of thin film solar cells with femto, pico and nanosecond pulse durations*, Proc. SPIE, 7409, 7409-10 (2009).
 D.J. Hwang et al., *Nanoscale Laser Processing and Diagnostics*, Applied Physics A, 96(2), 289 (2009).
 H. Pan, D.J. Hwang et al., *High-Throughput Near-field Optical Nanoprocessing of Solution Deposited Nanoparticles*, Small, Vol. 6, pp. 1812-1821 (2010).

RESEARCHER PROFILE

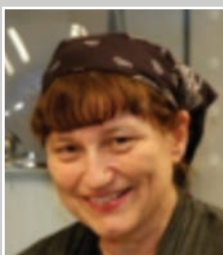

Miriam Rafailovich, Distinguished Professor, Undergraduate Program Co-Director (CME), Department of Materials Science and Engineering, AERTC Chief Scientist.

Awards and Honors:

- Lady Davis Fellowship
- Long Island Technology Hall of Fame Inductee
- SUNY Chancellors Award for Research in Science, Engineering, and Medicine (2007)
- Fellow, American Physical Society
- Siemens Foundation Recognition Award as Outstanding Mentor for the Westinghouse, Competition in Math, Science, and Technology

Energy Projects:
 Bioenergy and Biofuels
 Photovoltaic and Fuel Cells
 Combustion
 Nanotoxicology
 Environmental Sustainability

PHOTOVOLTAIC AND FUEL CELLS

Thin Film Solar Cells with Tunable Transparency

PIs: T. A. Venkatesh, SBU and Mircea Cotlet, BNL

Solar technologies are currently based on conventional solar cells made out of inorganic materials like silicon which are generally opaque. Organic semiconducting materials, including conjugated polymers, have been investigated as potential replacement materials for solar cells. Conjugated polymer-based organic photovoltaic solar cells have several attractive features such as being made of inexpensive materials by cost-effective processing methods like printing techniques, dip or spin casting, requiring low amounts of active material (around 100 nm thick layer) and being light weight and mechanically flexible. However, even at thicknesses of around 100 nm, these continuous thin films also tend to be quite opaque, restricting their application for integrated photovoltaics such as power-generating windows. In order to obtain transparent solar cells, recent efforts have focused on reducing the thickness of the active layer to less than 100 nm, which improves the transparency but drastically reduces the conversion efficiency of the solar cells. Hence, the overall objective of our research effort is to develop conjugated polymer based thin films with a novel micro-porous structure as active materials for solar cells with tunable transparency and good photovoltaic properties. (DOE)



Nanoparticle Enhancement of Polymer Electrolyte Membrane Fuel Cell Power Output

PI: Miriam Rafailovich, SBU

PEM fuel cell technology is one of the most promising future alternative energy sources because it has relatively low-operating temperature, high-power density, quick response and pollution-free operation. However, its relatively low power output compared to that of its price has prevented it from many practical applications. Nanoparticles have been widely known to possess catalytic capabilities. Some predicted that gold nanoparticles that are platelet shaped and have direct contact to the substrate to be the "perfect catalysts, if they could actually be produced. We found that under the optimal flow rate of 0.1 SCFH, the addition of nanoparticles resulted in a more than 500% increase in the power output of the fuel cell. One major limitation of the current PEM technology is the reduction of power as the current is increased past a maximal value. Nanoparticle enhanced PEM membranes do not seem to have that limitation and no current maximum has yet been determined. Hence, the actual power enhancement at high current loads could actually be far greater than the quoted value. Further research is in progress to determine this limit and the specific catalytic reaction which is responsible for this increase. This advancement represents a major step in the production of PEM cells for commercial high power applications. (NSF-MRSEC)



Developing Self-cleaning Glass for Solar Panels

PI: Alexander Orlov, SBU

The solar photovoltaics (PV) industry is experiencing a significant global growth. According to the European Photovoltaic Industry Association, the global PV capacity rose from 39.7 GW at the end of 2010 to more than 68 GW at the end of 2011. Capturing this growth in the US in general and in the NY State in particular can bring tremendous opportunities for energy independence, job creations and economic competitiveness. Increasing electricity output from the solar panels, even by few percents, can translate into billions of dollars in savings.

Developing self-cleaning solar panels can have a transformative impact on PV industry. Solar panel surface contamination (soiling) results in significant decrease in output and or/increase in maintenance costs. Some studies shown a decrease in solar cells output by 4 – 10 % on average in the first year of operation due to soiling. For example, the US based Solar Electric Power Association (SEPA) found that photovoltaic electricity output can decline by about 10% during the first year of operation due to accumulation of dirt, dust and other residues.

The project our group is currently working on can help to increase the PV output via two transformative solutions fitted within the supply chain:

- 1) coating solar panel glass before solar panel assembly to introduce self-cleaning properties;
- 2) treating the existing solar panels already installed in NYS to make them self-cleaning.

This novel approach can be tremendously beneficial in increasing energy efficiency of the existing and future PVs installations. (SBU, Powerbridge, NYSERDA)



PHOTOVOLTAIC AND FUEL CELLS

Enhancing the Power Output of Polymer Electrolyte Membrane Fuel Cells (PEMFC) Through the Deposition of Monolayer Gold Nanoparticle Platelets onto Nafion® Membranes

PI: Miriam Rafailovich, SBU

In our experiment, thiol-functionalized spherical gold nanoparticles (around 2nm in diameter) were synthesized through the two-phase method developed by Brust et al. When a solution containing these particles was spread at the air/water interface, X-ray reflectivity and EXAFS spectroscopy indicated the formation of platelet shaped particles. Langmuir-Blodgett (LB) trough was then used to deposit monolayer of these platelet shaped gold nanoparticles onto the surface of Nafion® membrane. Up to 80% enhancement for output power of a single cell and 33% enhancement for three stacked cells were found after applying the modified Nafion® membrane on PEMFC. Effects of gold nanoparticles are studied by varying the surface pressure (to deposit gold nanoparticles onto membrane) and gases at cathode side. Cyclic voltammetry and oxygen reduction reaction activity will be measured to

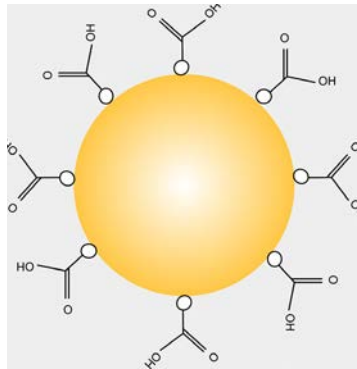

further investigate the activity of this kind of gold nanoparticles. (NSF)



Development of Monolithic Integration Technologies for Flexible CIGS Solar Modules Using All-Laser Scribing

PI: David J. Hwang, SBU

Practical challenge in utilizing renewable solar energy is reducing the cost per watt and simultaneously improving conversion efficiency to compete with current fossil fuel technology. Flexible CIGS thin film solar cells have shown remarkable cell efficiency, and deformable characteristic of flexible substrates enables cost-effective roll-to-roll production path. Portable or building integrated power sources are example of useful applications. Main objective of this project is to develop monolithic CIGS thin film solar cell fabrication technology on flexible substrate by thin film process optimization and precision laser processing. Techniques for all-laser CIGS thin film solar cell module interconnect technique specifically compatible with roll-to-roll process are under development. (Korea Institute of Energy Technology Evaluation and Planning)

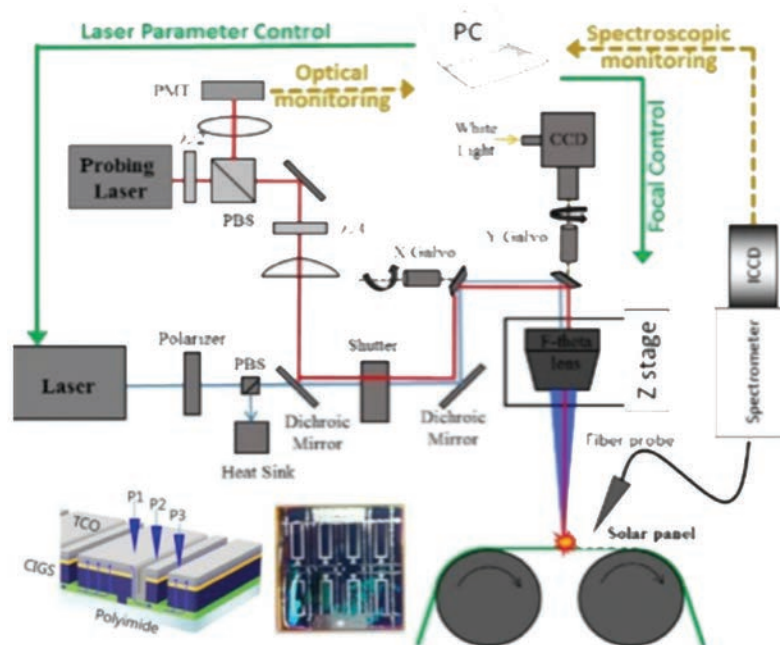

PHOTOVOLTAIC AND FUEL CELLS

Engineering Environmentally Responsible Flame Retardant Materials for Energy Delivery

PI: Miriam Rafailovich, SBU

Ethylene-vinyl acetate (EVA) is an elastomeric copolymer known for its excellent tactile properties in the adhesive industry [1]. Its high ductility also makes it an attractive component of polymer blends where it can provide a very large range of thermo-mechanical properties with broad applications in areas as disparate as footwear and electronics. In particular, EVA blends have been promoted as an environmentally friendly alternative to polyvinyl chloride (PVC) in cable sheathing. PVC has been traditionally used for producing the insulation and sheathing of cables due to its resistance to corrosion, flame retardancy, and ductility. However, processing PVC involves the release of a toxic by-product, dioxin, a highly dangerous and carcinogenic chemical. Another potential hazard of using PVC is the plasticizers leaking. Adding plasticizers can further enhance the ductility of PVC to fulfill the requirements of cable sheathing, but these chemicals are suspected carcinogens and easily leak out from the PVC matrix, where they can enter the environment, pollute water systems, and cause significant harm

to animals and humans. We have successfully engineered a flame retardant ethylene-vinyl acetate (EVA) composite which has similar mechanical properties to polyvinyl chloride (PVC) and therefore may prove to be an alternative material for cable sheathing, which is as effective, without the adverse effects on the environment. Four composites were studied, EVA with aluminum hydroxide (ATH), EVA with ATH and molybdenum disulfide (MoS₂), EVA with ATH and graphene nanoplatelets (GNPs), and EVA with all three components. Tensile testing showed nearly identical results for the EVA/ATH and EVA/ATH/MoS₂ compounds, while the EVA/ATH/GNPs compound had higher mechanical properties. The compound containing all three components showed further enhanced mechanical properties, indicating that a synergy was established. This was further confirmed using Scanning Electron Microscopy (SEM) where GNPs were seen to increase the dispersion of the MoS₂ and ATH components within the polymer matrix. Cone calorime-

try test clearly showed a large decrease in heat release rate when GNPs were added, which was further enhanced by adding GNPs and MoS₂ together. Application of the UL-94 test confirmed that the new nanocomposite could achieve the UL-94 V0 rating, indicating that it met stringent flame retardant criteria. (SBU)



Reference:
Capitalizing on the molybdenum disulfide/graphene synergy to produce mechanical enhanced flame retardant ethylene-vinyl acetate composites with low aluminum hydroxide loading. Yichen Guo, Yuan Xue, Xianghao Zuo, Linxi Zhang, Zhenhua Yang, Yuchen Zhou, Clement Marmorat, Shan He and Miriam Rafailovich, *Polymer Degradation and Stability* 144 (2017) 155e166.
Support from NY State Center for Advanced Technology and ICL Industrial Products. We would also like to acknowledge the Advanced Energy Center for access to the ThINC facility.

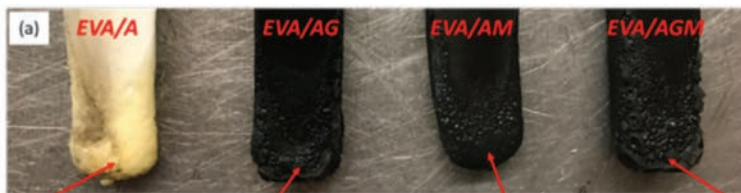

Optical image of burnt UL-94 samples: (a) From left to right: EVA/A, EVA/AG, EVA/AM and EVA/AGM. SEM images taken on the burnt surface (indicated by red arrows): (b) EVA, (c) EVA/AG, (d) EVA/AM, and (e) EVA/AGM.

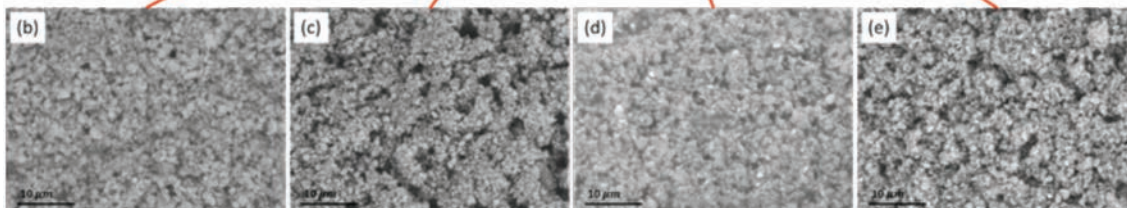

Optical image of burnt UL-94 samples: (a) From left to right: EVA/A, EVA/AG, EVA/AM and EVA/AGM. SEM images taken on the burnt surface (indicated by red arrows): (b) EVA, (c) EVA/AG, (d) EVA/AM, and (e) EVA/AGM.



TOP: PVC wire cables Bottom: Optical image of burnt UL-94 samples: (a) From left to right: EVA/A, EVA/AG, EVA/AM and EVA/AGM. SEM images taken on the burnt surface (indicated by red arrows): (b) EVA, (c) EVA/AG, (d) EVA/AM, and (e) EVA/AGM.

COMBUSTION

Application of Nanometer and Sub-nanometer Particles for Clean Fuel Production

PI: Alexander Orlov, SBU

Nanotechnology can potentially resolve many energy challenges. By tuning the size of materials used in energy production, it is possible to achieve breakthrough in their performance. In addition, it is possible to employ a bottom up approach, whereby building nanoparticles from few atoms to hundreds of atoms we can create new catalysts with unprecedented performance. In this project we are using new approaches in creating a new generation of nanomaterials with sizes ranging from nanometers to sub-nanometers. They have achieved several orders of magnitude better performance than the traditional catalysts used for sustainable energy production. (NSF)



Publication:
P. Shen, S. Zhao, D. Su, Y. Li, A. Orlov. *Outstanding activity of sub-nm Au clusters for photocatalytic hydrogen production*. *Applied Catalysis B: Environmental*, 25, 153-160. (2012).

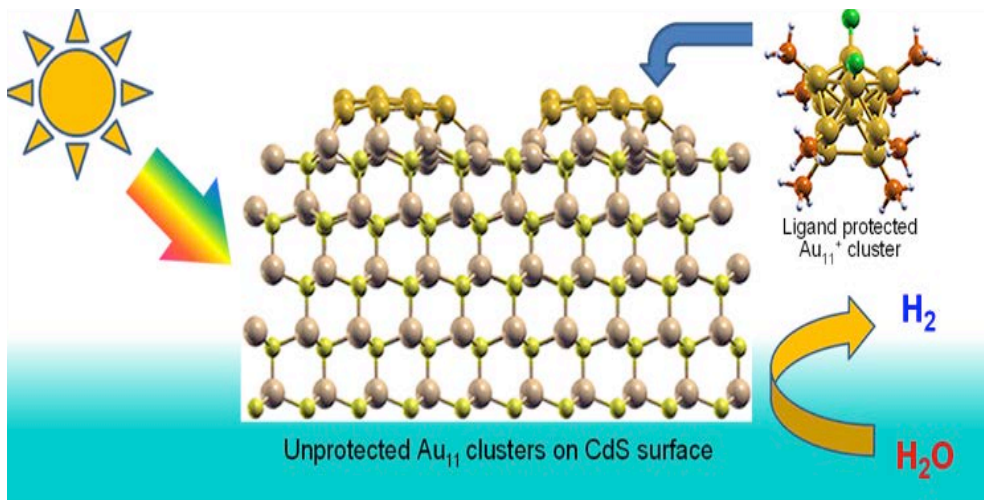

The “Lumburnator”: A Next Generation Wood Stove

PIs: Devinder Mahajan, John Longtin, Vladimir Zaitsev, SBU and Thomas Butcher, BNL

Biomass combustion is a major source of airborne particulate matter (PM) in the northeastern region of the United States. Hence, the reduction of PM emitted by biomass fired home heating appliances, especially wood stoves, has been identified as a priority in New York State. A desirable wood stove must operate near the stoichiometric air ratio. A novel combustion chamber is being developed with a geometric configuration (firebox dividers) and an air flow system (AFS) and a propane fired afterburner system (PFAS) for evaluation to design a better wood stove. (NYSERDA).



Developing and Investigating the Chemical and Mechanical Aspect of Cu/Zeolite Catalysts for Selective Catalytic Reduction of NO_x by NH₃ (NH₃-SCR)

PI: Tae Jin Kim, SBU

Stringent environmental regulations of the greenhouse gases, such as NO_x, emissions have driven extensive research in new and advanced functional materials. Recently, US Environmental Protection Agency (EPA) and Department of Transportation's National Highway Traffic Safety Administration (NHTSA) passed new regulations on fuel economy and emission standards. The enforced standards are 20mg/mile for NO_x emission. NO_x (NO and NO₂) are exhausts from automobiles (especially diesel cars, 95% NO and 5% NO₂) and stationary sources, such as power plants, during combustion of fossil fuels. Due to high activation energy barrier (364 kJ/mol) conversion of NO into non-toxic gases such as nitrogen and water, is very difficult even if the reaction is thermodynamically favorable ($\Delta G = -86 \text{ kJ/mol}$).

Thus, to decrease the activation energy, advanced heterogeneous catalysts design and different NO decomposition reaction pathways (selective catalytic reduction (SCR) and lean NO_x trap (LNT)) should be developed. Zeolite supported catalysts (e.g., Fe- or Cu-ZSM5, SSZ-13, BEA, Y) and mesoporous materials (SBA15) are currently being used and have been extensively investigated for diesel car applications.

Our group has designed and constructed an apparatus to conduct a preliminary study of the SCR of NO_x with standard zeolites (MFI, FAU, MOR and CHA) and supported zeolite catalysts. Based on the pore size, dimensionality, number of membered ring and oxidation state of surface species (Cu or Fe), we hypothesized significant differences in the conversion of NO and products selectivity during the SCR reactions. In addition to the zeolite structures, because water concentrations are critically affected on the catalyst deactivation, we also considered water vapor in an apparatus. Figure 1 (above) shows a schematic and installed system of the

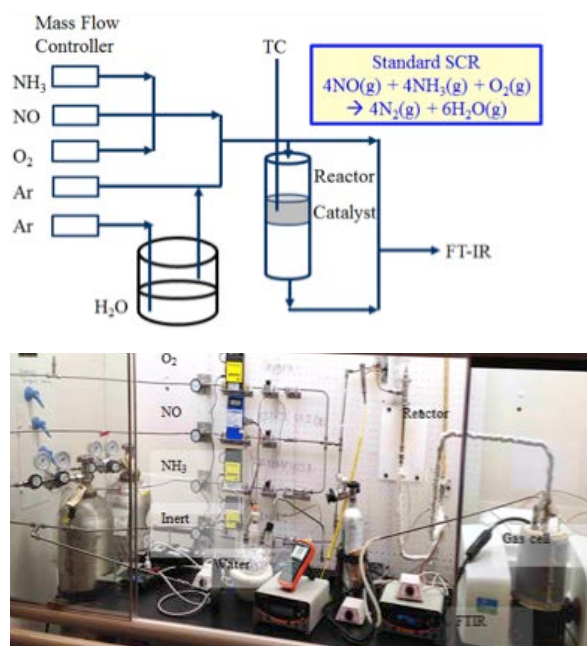

Figure 1. Schematic diagram of NH₃/SCR system

NO_x treatment SCR reaction. To measure the converted gas products, FTIR spectrometer, which combined with a spectroscopic gas cell, has been used. Our research team has tested standard zeolite catalysts using the FTIR spectroscopic techniques and obtained very low (<10% NO conversion) catalytic activity, which was similar to previous reports. Using the Cu-SSZ-13, however, the maximum NO and NH₃ conversion shows of 91% and 90% respectively at 300°C. (Figure 2) This result suggested that our group successfully designed and constructed a set-up that could be used for the investigation of the SCR of NO with NH₃ and will continue to be used for further studies. Future studies to continue this work include further development of catalysts with

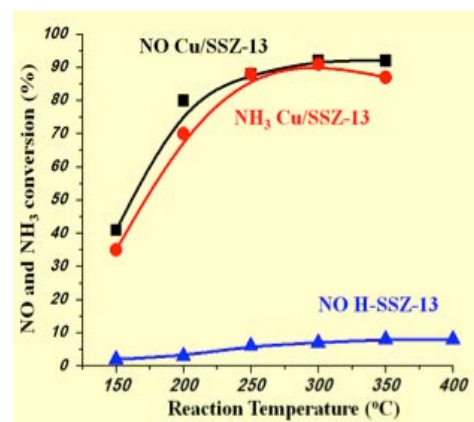

Figure 2. NO conversion versus temperature for Cu-SSZ-13 (square, black) and H-SSZ-13 (triangle, blue) catalysts. NH₃ conversion versus temperature for Cu-SSZ-13 (circle, red) is also shown.

several synthesis methods and analysis of intermediate species via the Operando study under a wider reaction temperature ranges. (SBU)



COMBUSTION

Low Temperature Combustion (LTC)

PI: Sotirios Mamalis, SBU

Low Temperature Combustion (LTC) engines have the potential to provide solutions to continuously evolving fuel economy and emissions regulations. By increasing compression ratio, boost and diluting through air or exhaust gas recirculation, researchers have created novel concepts such as HCCI, RCCI and SACI. These engine concepts can achieve high combustion and thermal efficiencies while keeping cylinder temperatures low for NO_x formation prevention. Research at the Internal Combustion Engines laboratory focuses on addressing some of the key challenges associated with advanced combustion engines, such as limited operating range, high pressure rise rates and instability. Addressing these issues will enable widespread adoption of advanced combustion engines by a range of light-duty to heavy-duty vehicles. (SBU)

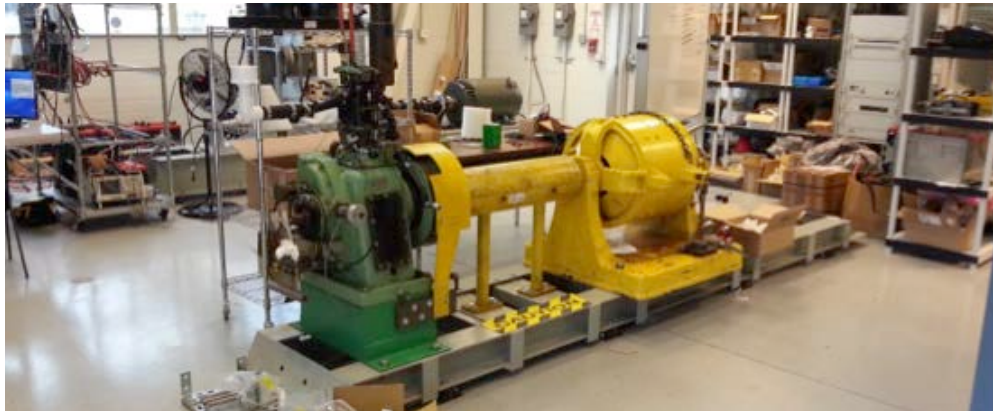
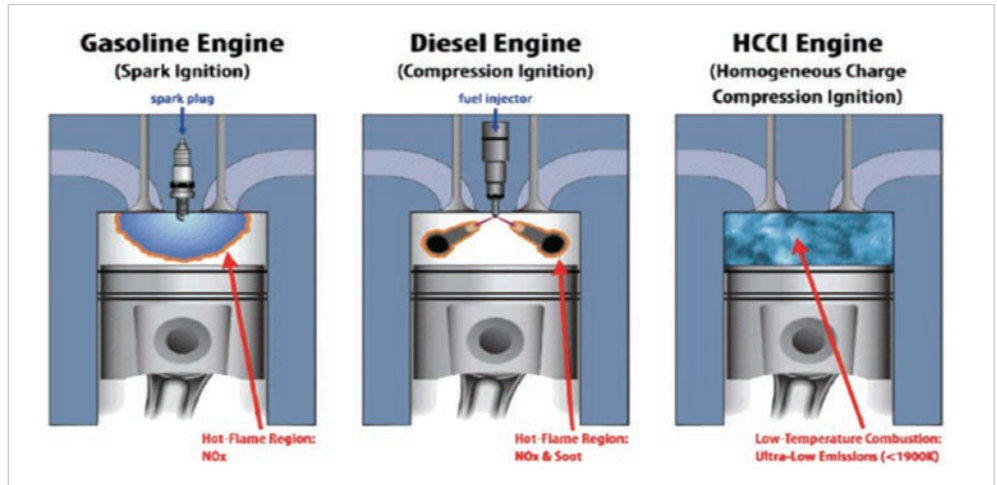

Publication:
S. Mamalis, A. Babajimopoulos, D. Assanis, C. Borgnakke.
A Modeling Framework for Second Law Analysis of Low Temperature Combustion Engines. International Journal of Engine Research, September 2014, 15 (6), 641-653. (2014).

RESEARCHER PROFILE



Sotirios Mamalis, Assistant Professor, Department of Mechanical Engineering, Stony Brook University

Awards and Honors:

- SAE Forest R. McFarland Award, 2018
- ASME, Internal Combustion Engines Division Fall Technical Conference Session Chair, 2016-2018
- SAE World Congress Session Chair, 2013-2018

Energy Projects:

Low temperature combustion engines for automotive and stationary power generation

Biofuels for internal combustion engines

Reactivity & Structural Dynamics of Supported Metal Nanoclusters Using Electron Microscopy, In-Situ X-Ray Spectroscopy, Electronic Structure Theories, & Molecular Dynamics Simulations

PIs: Anatoly Frenkel, SBU and
 Ralph Nuzzo, UIUC

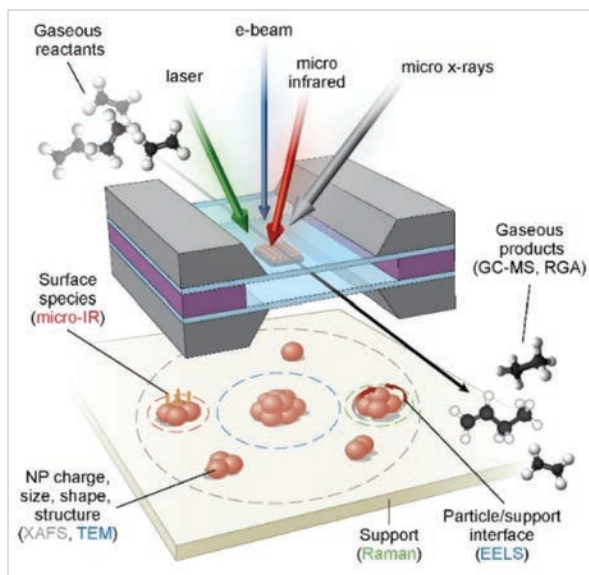

Correlative, multi-modal investigation of catalytic materials by photon and electron probes in the same microreactor and in operando conditions.

In a program of collaborative research, we will develop a deep quantitative understanding of the complex dynamical attributes of the atomic and electronic structures of supported metal-cluster catalysts as they exist under operando conditions. We will focus on supported mono- and bimetallic clusters in sub-to 5nm size range. We will also investigate the mechanisms responsible for effects on the physico-chemical properties of the materials (such as statistics of the particle size distributions, shape, composition, metal-support interactions, and operando dependent atomic and electronic structural properties). Our goals are: 1) Unveiling the correlations between dynamic structure, electronic properties, and reactivities in nm-scale catalysts; and 2) Development of new analytical methodologies that will test and validate advanced

techniques enabled by the NSLS-II synchrotron at Brookhaven National Laboratory and theory-directed means of computational modeling. The work will establish integrated efforts to develop new techniques for studying nanoscale catalysts in the environments of operating processes, and establish benchmarks of methods appropriate for dissemination to the broader catalysis community. (DOE BES)



Publication:
 Y. Li, D. Zakharov, S. Zhao, R. Tapper, U. Jung, A. Elsen, Ph. Baumann, R. G. Nuzzo, E. A. Stach, A. I. Frenkel - *Complex structural dynamics of nanocatalysts revealed in operando conditions by correlated imaging and spectroscopy probes*. Nature Commun. 6, 7583 (2015).

RESEARCHER PROFILE



Benjamin Lawler, Assistant Professor, Department of Mechanical Engineering, College of Engineering and Applied Sciences, Stony Brook University

Awards and Honors:

- Department of Mechanical Engineering Students' Choice Award for Excellence in Teaching, 2017 and 2018
- Stony Brook University College of Engineering and Applied Sciences Dean's Award / Millionaires Club, 2016
- Society of Automotive Engineers Outstanding Oral Presentation Award, 2014
- ASME Internal Combustion Engine Division Spring Technical Conference Best Presentation Award, 2012
- National Science Foundation Graduate Research Fellowship, 2010

Energy Projects:

High Efficiency Engines
 Advanced Combustion Concepts
 Alternative Fuels for Engines

COMBUSTION

Single-Fuel Reactivity Controlled Compression Ignition Combustion Enabled by Onboard Fuel Reforming

PIs: Benjamin Lawler, Sotirios Mamalis, SBU and Dennis N. Assanis, UD

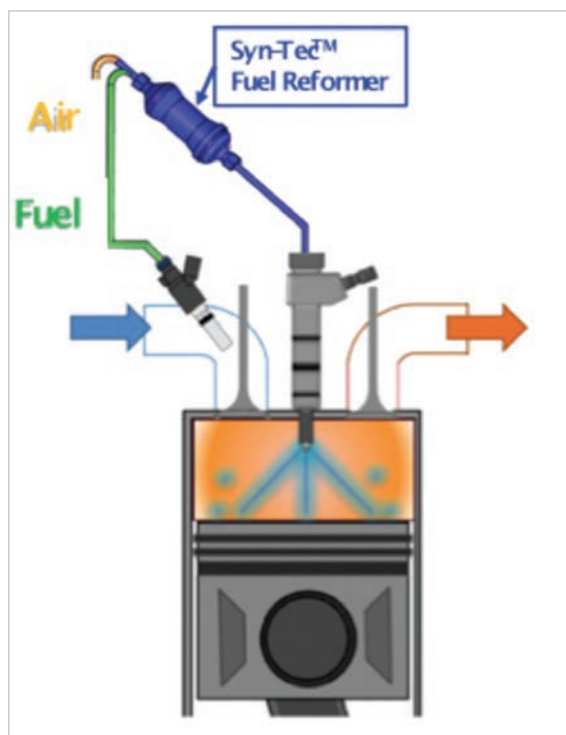

Figure 1. Parent Fuel-Reformate RCCI (figure modified from [1]) [1] Curran, S., Gao, Z., and Wagner, R., "Reactivity Controlled Compression Ignition Drive Cycle Emissions and Fuel Economy Estimations Using Vehicle Systems Simulations with E30 and ULSD," SAE Int. J. Engines, 2014.

Reactivity Controlled Compression Ignition (RCCI) combustion is an advanced combustion concept that uses two fuels with distinct autoignition properties to provide significant and simultaneous reductions in fuel consumption and emissions compared to more conventional combustion modes. Due to its potential, RCCI has been researched extensively over the past decade by academia and national laboratories and the benefits have been well documented. However, the added cost and complexity of the two completely separate fuel systems (tanks, pumps, injectors, etc.) have thus far precluded industry's interest in RCCI.

The proposed concept is to use an onboard fuel reformer to enable RCCI with a single fuel, thereby removing the last practical limitation. A fuel reformer reacts and chemically alters a parent fuel into reformate: a mixture of hydrogen, carbon monoxide, and other partially reacted hydrocarbon species. The autoignition properties of the reformate are uniquely different from the parent fuel. Therefore, by using an onboard fuel reformer and a parent fuel and its reformate, RCCI is theoretically achievable from a single fuel (the parent fuel). The goal of this research is to evaluate the proposed concept and quantify its performance metrics; thermal efficiencies, engine-out emissions, etc.

In order to test the proposed concept, three possible parent fuels with potential for automotive applications will be reformed to varying degrees in a fuel reformer and the properties of their reformate mixtures will be characterized. Based on these properties, several parent fuel-reformate pairs will be selected for experimental engine testing at the Advanced Combustion Laboratory in

the Advanced Energy Research and Technology Center at Stony Brook University. In addition to experimental testing, computational fluid dynamics (CFD) modeling and simulation of parent fuel-reformate RCCI will help to gain a better insight into the conditions in the cylinder and the operating strategies and fuel pairs that offer the most promise. In both the experimental engine testing and the CFD modeling, the goal will be to evaluate the potential performance metrics of interest will be the efficiency, engine-out emissions, and the operating range of each parent fuel-reformate pair.

If successful, the implications of this proposed concept are immense. RCCI has already demonstrated significant fuel economy improvements and emissions reductions. This research will enable the implementation of RCCI in a vehicle application and allow the realization of the previously reported fuel economy and emissions benefits. (DOE, Innoveering LLC, CCNY)



COMBUSTION

Miniature Internal Combustion Engine for Transformational Residential Applications (MICE TRAP)

PIs: Sotirios Mamalis, Ben Lawler, Jon Longtin, SBU and Dennis N. Assanis, UD

Free-piston linear alternators have the demonstrated potential to achieve high electrical conversion efficiency, based on their variable compression ratio, ability to ignite lean mixtures, and low friction. Aero-dyne Research, Inc. (ARI) and Stony Brook University (SBU) propose the development of a small single-cylinder, 2-stroke free-piston engine integrated with a linear alternator and a machined multiple helix spring, based on ARI's Miniature Internal Combustion Engine (MICE) generator technology. Transformational advances include:

- Homogeneous Charge Compression Ignition (HCCI) Combustion: HCCI offers high thermal efficiency, low emissions, compatibility with large amounts of residual gas, and is facilitated by the variable compression ratio. HCCI has been successfully demonstrated on a 300 W prototype free-piston engine using propane and Jet-A fuels, and glow plug-assisted ignition.
- Spring for energy storage: The spring stores 5-10 times the work output of an engine cycle, and offers high frequency operation, which is key to high energy density, compact size, low weight, and

low cost. It also improves controllability of the free-piston generator.

- Permanent magnet alternator: Uses a moving coil for low active mass. This design uses stationary electrical leads from the moving coil without the use of sliding contacts.
- Fixed cycle frequency: Allows tuning for effective cylinder scavenging and low exhaust noise, as well as effective vibration isolation and cancellation. Quiet operation will be achieved with specially designed acoustic packaging.
- Low emissions: Glow plug assisted HCCI combustion offers low NO_x, low CO, UHC and CH₄ (high combustion efficiency), low VOC (active lubrication), and zero PM emissions.
- Active lubrication: A spring-activated piston squirt lubrication system will be designed that will provide high durability and prevent oil from entering the combustion chamber.

The complete 1 kWe MICE TRAP system is expected to weigh 30 kg and cost < \$2,000. It will achieve 40% electrical conversion efficiency, and comply with CARB

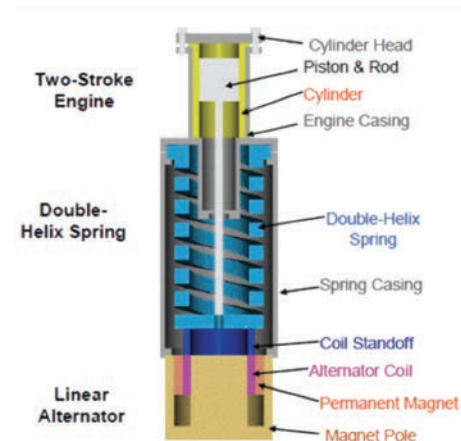

Figure 1: MICE Generator Design (Image taken from Annen, K.D., Stickler, D. B., and Woodroffe, J., *Miniature Internal Combustion Engine-Generator for High Energy Density Portable Power*, in 26th Army Science Conference, 2008)

2007 emissions regulations for distributed generation, by making selective use of after treatment systems. (ARPA-E, Aero-dyne Research, Inc.)



Dedicated Beamline Facilities for Catalytic Research: Synchrotron Catalysis Consortium (SCC)

PIs: Anatoly Frenkel, SBU and Jingguang Chen, Columbia

Synchrotron spectroscopies offer unique advantages over conventional techniques, including higher detection sensitivity and molecular specificity, faster detection rate, and more in-depth information regarding the structural, electronic and catalytic properties under in-situ reaction conditions. Despite these advantages, synchrotron techniques are often underutilized or unexplored by the catalysis community due to various perceived and real barriers, which will be addressed in the current proposal. Since its establishment in 2005, the Synchrotron Catalysis Consortium (SCC) has coordinated significant efforts to promote the utilization of cutting-edge catalytic research

under in-situ conditions. These tasks in 2017-2020 will be performed by a consortium consisting of PIs and collaborators with extensive experience in the areas of catalysis, electrocatalysis and synchrotron techniques. The combined expertise of the team members will continue to create the synergy that is necessary to ensure the success of the dedicated beamline facilities and infrastructures for in-situ catalytic studies for the catalysis community. (DOE BES)



Publication: A. I. Frenkel, J. A. Rodriguez, J. G. Chen, *Synchrotron techniques for in situ catalytic studies: Capabilities, challenges and opportunities*. Invited Perspective Article, ACS Catalysis 2, 2269-2280 (2012).

Naphthenic Biofuel-Diesel Blend for Optimal Mixing Controlled Compression Ignition Combustion

PI: Sotirios Mamalis, Benjamin Lawler, SBU

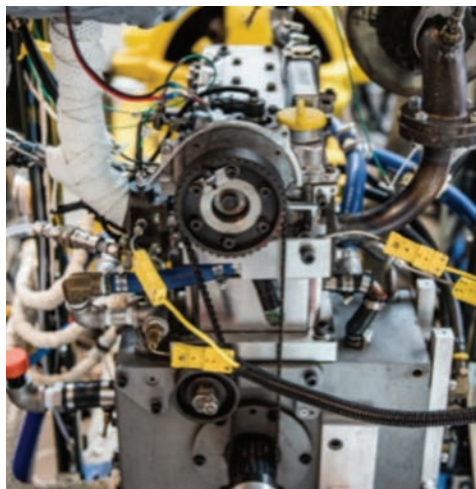

Mixing Controlled Compression Ignition (MCCI) engines are widely used in medium- and heavy-duty (MD/HD) vehicles due to their efficiency benefits and are expected to continue to be used in the future. However, it is well understood that the highly heterogeneous, mixing controlled combustion process results in soot and nitrogen oxides (NO_x) formation.

Numerous studies have investigated the fundamental processes of mixing controlled combustion and have attributed the soot formation to the rich zones formed in the combustion chamber from the spray, and the NO_x formation to the high temperature and near-stoichiometric zones that have high burned gas temperatures. This heterogeneous combustion process necessitates that soot, NO_x, carbon monoxide (CO), and unburned hydrocarbons (UHC) emissions from MCCI combustion are treated in the exhaust by emissions control systems. The current MCCI engine technology has been developed and established based on conventional diesel fuel; however, biofuels that can be mixed with diesel hold promise for providing solutions for future sustainable transportation.

Using bio-derived fuels offers the potential for a reduction in lifecycle greenhouse gas emissions, as well as the ability to manipulate certain properties of the finished fuel to promote spray atomization and fuel-air mixing, improve cold start performance, and inhibit soot formation. Direct biomass liquefaction provides a unique opportunity to create a

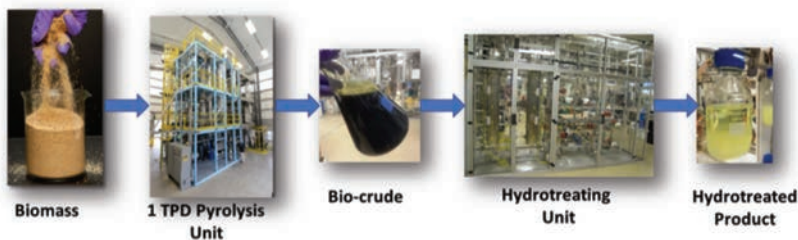

wide range of bio-derived fuels and products that can improve the environmental performance of petroleum-based products while also stimulating the U.S. economy. Biofuels or bio-derived components produced from different conversion pathways (biochemical, thermochemical, and chemical/hybrid) tend to vary with respect to molecular structure and physical properties. Naphthenic hydrocarbons (cycloalkanes and alkyl-cycloalkanes) can readily be produced from biomass through existing thermochemical conversion pathways (pyrolysis followed by hydrotreating). Naphthenes are hydrocarbons between normal paraffins and aromatics. Therefore, they can be used to adjust the properties of the finished fuel. However, knowledge of the impact of blending a naphthenic hydrocarbon derived from biomass on the diesel fuel properties and combustion is limited.

Therefore, Stony Brook University (SBU) has partnered with RTI International to: 1) develop a fundamental understanding of how naphthenic molecules influence the diesel fuel chemistry through the use of surrogate fuels; 2) produce a naphthenic distillate bio-blendstock from loblolly pine feedstock, and 3) blend the produced bio-blendstock with diesel fuel at different concentrations in order to test it in a research engine and assess its effects on the MCCI combustion process.

The Engine Combustion Research Group (ECRG) at Stony Brook University (stonybrook.edu/combustion) is a team of researchers investigating the next generation of engine technologies with the goal of improving efficiency and reducing emissions formation. SBU has expertise in experimental testing and modeling of conventional and advanced combustion engines and has established a comprehensive research program, which includes federally and state-funded research as well as industrial collaborations. RTI International is a non-profit research institute headquartered in Re-

search Triangle Park, North Carolina. Energy research is one of the core practice areas of RTI and is focused on developing efficient, economic, and sustainable energy solutions that address global concerns. The scientific staff at RTI have core expertise in biomass conversion technology for the production of fuels and chemicals. The objective of the proposed project is to investigate and demonstrate the use of a naphthenic distillate as a multicomponent liquid bio-blendstock for use in MD/HD MCCI engines. The hypothesis is that the addition of the biomass-derived naphthenic distillate will reduce the concentration of normal paraffin (poor cold weather behavior) and aromatics (high propensity for soot formation) and thus improve the finished blended fuel. Surrogate fuel studies will be performed to fundamentally understand how the naphthenic bio-blendstock chemistry determines fuel properties and engine performance. The naphthenic bio-blendstock will be produced from loblolly pine feedstock and will undergo full fuel composition analysis. Through composition analysis, the project team will assess the impact of the bio-blendstock on key properties of the finished fuel, such as energy density, sooting propensity, cetane number, and cold weather behavior.

Fuel blends of different concentrations starting from 5% vol. of bio-blendstock will be prepared for experimental testing in a single-cylinder diesel research engine, which is equipped with state-of-the-art fuel injection equipment, instrumentation, and data acquisitions systems. The engine-out emissions recorded from experimental testing will be used to demonstrate the potential of the proposed biofuel to reduce the lifecycle greenhouse gas emissions by 50% compared to conventional petroleum-derived diesel. (DOE)



Design of Nanostructured Tungsten Alloys for the Future of Fusion Energy

PI: Jason R. Trelewicz, SBU

Tungsten has emerged as a promising candidate material for the high heat flux divertor region of future fusion reactors due to its high melting point, good thermal conductivity, creep resistance, high temperature strength, sputtering resistance, and chemical compatibility with tritium. However, the potential for transient events in ITER and an eye toward DEMO raises concerns about tungsten's recrystallization temperature, oxidation resistance, long-term radiation tolerance, and mechanical performance. The technical aim of this research is to address these limitations in tandem by precisely tailoring the volume fraction, chemistry, and structural state of grain boundaries in nanostructured tungsten alloys. (DOE)

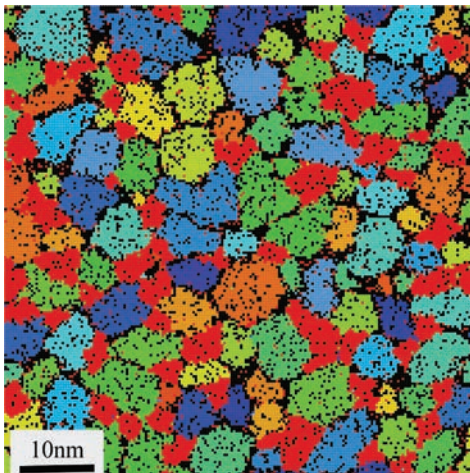

Figure 1: Representative grain model of a nanostructured W-Ti-Cr alloy where Ti (black) and Cr (red) are designed into the tungsten microstructure (other colors represent W grains) to stabilize the grain boundary network against grain growth and recrystallization while simultaneously enhancing mechanical performance.

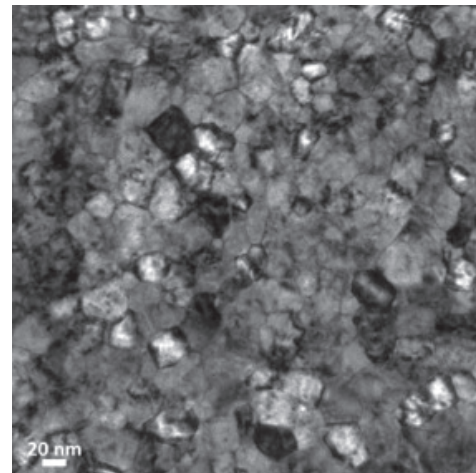

Figure 2: Electron micrograph of a nanostructured W-Ti alloy irradiated with high-energy gold ions to explore the radiation tolerance of this novel material, which was produced based on the insights gained through the model shown in Figure 1.



Publications

W.S. Cunningham, J.M. Gentile, O. El-Atwani, O. C.N. Taylor, M. Efe, S.A. Maloy, J.R. Trelewicz. *Softening due to Grain Boundary Cavity Formation and its Competition with Hardening in Helium Implanted Nanocrystalline Tungsten*. Scientific Reports, 8, 2897 (2018).

O.K. Donaldson, K. Hattar, T. Kaub, G.B. Thompson, J.R. Trelewicz. *Solute Stabilization of Nanocrystalline Tungsten Against Abnormal Grain Growth*. Early Career Scholars in Materials Science: Invited Feature Article, Journal of Materials Research, 33, 1 (2018).

RESEARCHER PROFILE



Energy Projects:
Materials for Fusion Reactors
Accident Tolerant Cladding
for Fission Reactors
Harsh Environment Sensors

Jason R. Trelewicz, Assistant Professor, Department of Materials Science and Engineering; Affiliate Professor, Institute for Advanced Computational Science; Director, IACS High Performance Computing Consortium, Stony Brook University

Awards and Honors:

- National Science Foundation CAREER Award, 2016
- Symposium Chair, International Symposium on Plasticity, 2016
- TMS Young Leader Professional Development Award, 2015
- Emerging Leaders Alliance Capstone Program, 2014
- Defense Manufacturing Conference Top Speaker Award, 2010

BIOENERGY AND BIOFUELS

Alternative Pathways for Biofuel Formation from Furfuryl Alcohol Over Heterogeneous Catalysts

PI: Tae Jin Kim, SBU

Due to the fluctuating petroleum price and increasing greenhouse gas emission, there is an extensive growing need to investigate renewable energy resources, such as biomass (or lignocellulosic biomass). Furfuryl alcohol (FA) has been considered as a key template chemical for value-added chemicals and fuels. Current research addresses challengeable FA conversion into diesel/jet fuel carbon ranges' hydrocarbon. Although homogeneous catalysts have been used for alcohol dehydration reaction, due to the catalysts recycling and wastes treatment issues, homogeneous catalysts should be replaced by heterogeneous catalysts. Our group have been investigating FA conversion into oligomers using heterogeneous catalysts, such as WO_3 , MoO_3 , Al_2O_3 , ZrO_2 , TiO_2 , SiO_2 , and Nb_2O_5 . Using the both analytic (GC/MS) and spectroscopic (Infrared and Raman) techniques, we successfully observed five dimers (2,2'-difurlymethane, 2-(2-furlymethyl)-5-methylfuran, difurfuryl ether, 4-furfuryl-2-pentenoic acid γ -lactone, 5-fufuryl-furfuryl alcohol) and two trimers (2,5-difurfurylfuran and 2,2'-(furylmethylene) bis(5-methylfuran)), and proposed possible FA

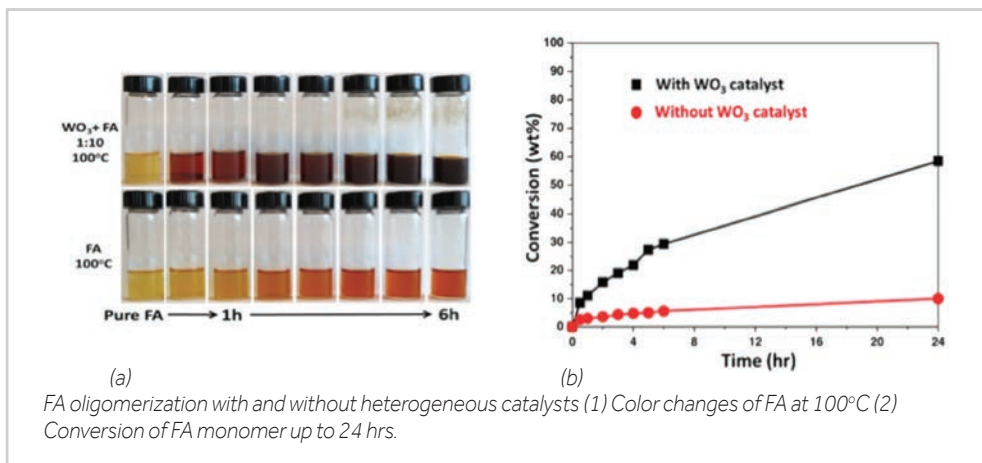

oligomerization reaction mechanism. It can be expected that controlling FA conversion rate and oligomer selectivity is possible over metal oxide catalysts. (NSF)



Publications:
T. Kim, J. Jeong, M. Rahman, E. Zhu, D. Mahajan, *Characterizations of furfuryl alcohol oligomer/polymerization catalyzed by homogeneous and heterogeneous acid catalysts*. Korean J. Chem. Eng., 31(12) 2124-2129 (2014).
X. Chan, W. Nan, D. Mahajan, T. Kim, *Comprehensive investigation of the biomass derived furfuryl alcohol oligomer formation over tungsten oxide catalysts*. Catal. Commun., 72 11-15 (2015).
X. Chan, A. Roy, C. Ooi, P. Yang, F. Morais, T. Kim, *Catalysts Loading Effect of Tungsten Oxide Catalytic Furfuryl Alcohol Oligomerization*. Materials Today: Proceedings, accepted (2016).

Fundamental Research of Cu/Zelite Catalyst During NOx Selective Catalytic Reduction: Structure-Catalytic Activity Relationship

PI: Tae Jin Kim, SBU

Selective catalytic reduction (SCR) of nitric oxide (NO_x) with Urea (or NH_3) as a reducing agent is considered to be one of the most effective ways to remove NO_x from mobile or stationary power sources. A variety of zeolite based catalysts, such as Cu- and Fe-exchanged MOR, MFI, BEA, and CHA, have been investigated for the abatement of NO_x . Among them, Cu exchanged into the CHA (chabazite) framework zeolites have been focused due to the higher NO_x reduction catalytic activity, better N_2 selectivity, and better hydrothermal stability than other zeolites. Fundamental understanding of the nature of Cu/CHA catalysts, reaction mechanism, and molecular/electronic structure-activity relationships is required for the rational design of current and new catalysts. Our group have been preparing Cu-exchanged zeolite catalysts and testing activity. Due to the complicated heterogeneity of 3D type catalysts, we synthesized 2D zeolite

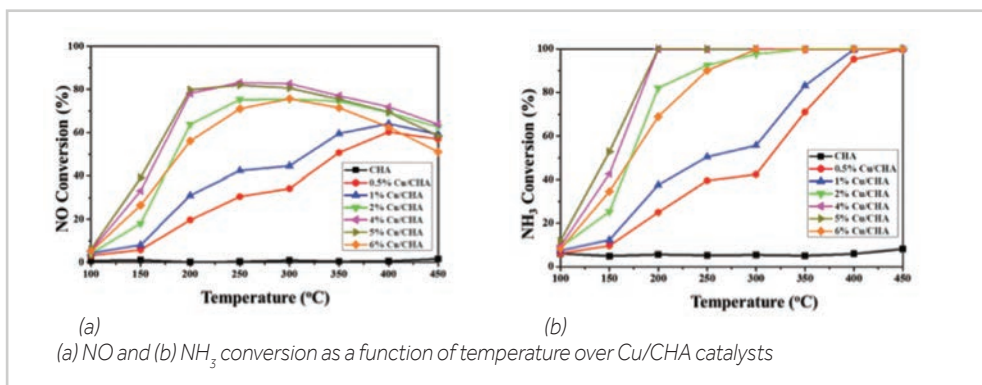

(or silicate) catalysts and do a comparative study of 3D-commercial zeolites using a 2D-model zeolites. Using the in-situ and Operando techniques, activity and surface reaction will be obtained simultaneously under a wider reaction temperature ranges. (SBU, BNL)

Stony Brook University
BROOKHAVEN NATIONAL LABORATORY

Publication:
N. Akter, L. Han, D. Huaman, Y. Kang, T. Kim, *NO and NH_3 Oxidation Over Zeolite Materials*. Materials Today: Proceedings, accepted (2016).

BIOENERGY AND BIOFUELS

Development of Cost-Effective Technology for Biogas Purification

PI: David Tonjes and Devinder Mahajan, SBU

Biogas, primarily a mixture of CH_4 , CO_2 , N_2 , H_2S , is a renewable source of methane (CH_4). Bio-methane extraction from biogas to make it pipeline-quality gas is of interest to electric utilities because renewable gas counts as CO_2 -net neutral fuel and qualifies for carbon credits. This proposed study is focused on developing an economical method to produce clean methane from landfill gas. Our ongoing collaboration with the USDA-ARS center in Florence, South Carolina on biomass pyrolysis shows that the availability of biochar from pyrolysis could be an opportunity to remove unwanted elements that form biogas produced from landfills. The recovered bio-methane could potentially displace about 10% of the imported natural gas used to produce electricity on Long Island. (Town of Brookhaven, NSF-CBERD)



Publication:
S. Patel, D. Tonjes, D. Mahajan. *Biogas Potential on Long Island, New York: A Quantification Study*. *J. Renew. Sustain. Energy*. 3, 043118; doi:10.1063/1.3614443 (2011).

Technical and Evaluation Analysis of Advanced Strategies for the Energy Valorization of Biomass

PI: Devinder Mahajan, SBU

A nine-country (Spain, UK, France, Greece, Chile, China, Japan, Canada and USA) consortium, led by the Universidad Politécnica de Madrid (UPM), Spain, has been awarded four-year funding of €302,000 by the European Commission (EC) under the Marie Curie International Research Staff Exchange Scheme (Marie Curie IRSES). NSF is providing funding to the U.S. PI to interface with the EC consortium on a developing joint program in biomass conversion into fuels and chemicals. The key deliverables are personnel exchange and joint proposal development. (NSF)



Development of a Flex Bio-Plant: Microemulsion-based Production of Bio-methanol and Bio-butanol from Biomass-derived Synthesis Gas

PIs: Devinder Mahajan, SBU, Scott Turn, U Hawaii, and Ponisseril Somasundaran, Columbia University

The slurry-phase MoS_2 catalyzed process to produce mixed alcohols shows that the system operates as a 4-phase system (catalyst/solvent/aqueous/gas) limiting mass transfer to produce mixed alcohols in low yields. The ongoing work envisions a microemulsion system in which the dispersed oil phase in water medium functions as a reservoir of nano-containers for the MoS_2 catalyzed reactions. The CO_2 in syngas, present in supercritical state under operating temperature and pressure, itself acts as the dispersed oil phase and is solubilized in a water medium using non-ionic surfactants. This would substantially enhance alcohol production rates through higher catalyst/gaseous reactant contact in the oil phase and excellent heat management through the dispersion medium. Also, selective partitioning of heavier products

into the oil phase helps in reducing the downstream fractionation load of mixed alcohols. The proposed partnership brings together expertise of two NSF centers: the Center for Advanced Studies in Novel Surfactants (ASNS) is formulating MoS_2 containing microemulsions that can be stable under operating temperatures and pressures and CBERD is conducting tests to evaluate the prepared microemulsions for mixed alcohols. A successful system would achieve the CO conversion per pass from < 20% to > 50% making this pathway a potential commercial process. (NSF-CBERD, US ARMY)

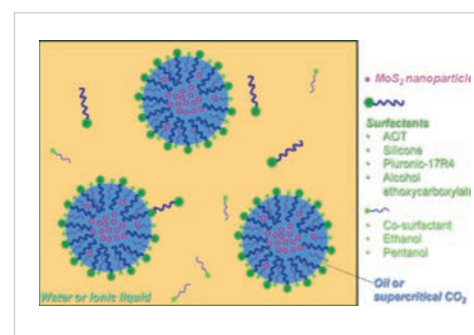

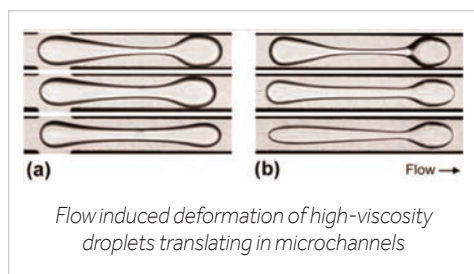

Microflow of Highly Viscous Fluids: Mixing and Dissolution Processes

PI: Thomas Cubaud, SBU

We experimentally study viscous multi-phase flows in transparent high-pressure microfluidic devices. Nanofabrication techniques allow for constructing complex flow geometries that can mimic fluidic networks encountered in nature, such as in trees, blood vessels, and porous rocks. Motivated by the development of techniques for controlling the structural and rheological properties of multi-fluid dispersions, research focus is on transport, diffusion, and capillary phenomena, including lubrication, droplet coalescence, and emulsification processes between low- and high-viscosity fluids at the microscale. A wide range of fluids is investigated, including those important to the energy sector, such as heavy oils, ethanol, and carbon dioxide to potentially discover new pathways for enhanced petroleum manipulations, continuous bio-fuel synthesis, and sequestration of greenhouse gases in porous networks. (NSF)



Publications:

T. Cubaud. *Deformation and breakup of high-viscosity droplets with symmetric microfluidic cross flows*. *Phys. Rev. E*, 80, 026307 (2009).

S. Darvishi, T. Cubaud. *Lubrication of highly viscous core-annular flows in microfluidic chambers*. *J. Fluids Eng*, 113, 031203 (2011).

T. Cubaud, B.M. Jose, S. Darvishi. *Folded micro-threads: Role of viscosity and interfacial tension*. *Phys. Fluids*, 23, 042002 (2011).

R. Sun, T. Cubaud. *Dissolution of carbon dioxide bubbles and microfluidic multiphase flows*. *Lab Chip*, 11, 2924 (2011).

NanoSulf™ Process for Effective Sulfur Removal

PI: Devinder Mahajan, SBU

Biogas, primarily a mixture of CH_4 , CO_2 , N_2 , H_2S , is a renewable source of methane (CH_4). Methane sources (landfills, wastewater facilities) naturally produce hydrogen sulfide (H_2S) contaminated "biogas" that pose nuisance to public. Once H_2S is removed, methane can be harvested for power and fuel use. NanoSulf™ is a self-renewing catalytic process that improves over commercial H_2S removal methods by requiring less frequent media changes and is a drop-in replacement, thus reducing capital and operational costs. The process is modular that moderates overall process cost by 30%. The proposed study focused on market assessment and potential of the technology for scale-up at the Town of Brookhaven landfill site. (PowerBridgeNY-NYSERDA).



Publication:

S. Patel, D. Tonjes, D. Mahajan. *Biogas Potential on Long Island, New York: A Quantification Study*. *J. Renew. Sustain. Energy*, 3, 043111; doi:10.1063/1.3614443 (2011).

Institute of Gas Innovation and Technology (I-GIT)

PI: Devinder Mahajan, SBU

Biogas, primarily a mixture of CH_4 , CO_2 , N_2 , H_2S , is a renewable source of methane (CH_4). Methane sources (landfills, wastewater facilities) naturally produce hydrogen sulfide (H_2S) contaminated "biogas" that pose nuisance to public. Once H_2S is removed, methane can be harvested for power and fuel use. NanoSulf™ is a self-renewing catalytic process that improves over commercial H_2S removal methods by requiring less frequent media changes and is a drop-in replacement, thus reducing capital and operational costs. The process is modular that moderates overall process cost by 30%. The proposed study focused on market assessment and potential of the technology for scale-up at the Town of Brookhaven landfill site. (National Grid, AERTC).



Publication:

D. Mahajan, C. Xiaoli, D. Tonjes. *Energy Harvesting and Utilization Potential of Fugitive Methane with Climate Change Consequence*. *Prog. Ener. & Comb. Sci.*, 56 33-70 (2016).

Design of Microchemical Systems for Discovery of Methane Science

PI: Ryan L. Hartman, NYU

Methane, a key component of our domestic natural gas resource, is used for energy and the sustainable production of chemicals. Methane gas can form crystalline sl hydrates with liquid water at elevated pressures and sub-cooled temperatures. This project investigated methane sl hydrate crystal growth kinetics by designing a microfluidic device capable of controlling nucleation via thermoelectric temperature cycling. This work was supported primarily by the MRSEC Program of the National Science Foundation under Award Number DMR-1420073. Methylations of aromatics are also useful steps in the preparations of fine chemicals and pharmaceuticals. The second project focuses on energy efficient catalytic routes to methane C-H activation, which involves

the design of microchemical systems for the study of a new family of homogenous catalyst. This work was supported by the National Science Foundation under Award Number CBET-1551116. (NSF)



Publications:

W. Chen, B. Pinho, R.L. Hartman. *Flash crystallization kinetics of methane (sl) hydrate in a thermoelectrically-cooled microreactor*. *Lab Chip*, 17, 3051-3060 (2017).

B. Pinho, Y. Liu, B. Rizkin, R.L. Hartman. *Confined methane-water interfacial layers and thickness measurements using in situ Raman spectroscopy*. *Lab Chip*, 17, 3883-3890 (2017).

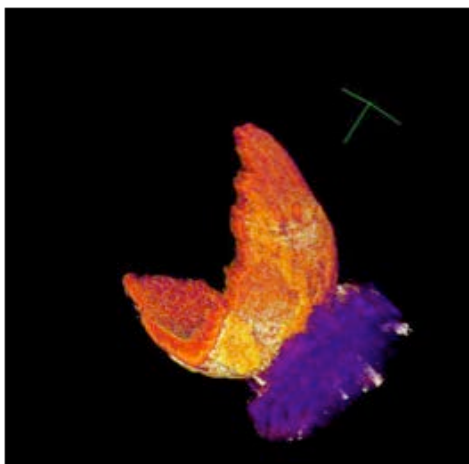

Turning Waste into Fuels, Soil Additives and Improved Construction Materials

PI: Alexander Orlov, SBU

This project is focused on several innovative approaches on utilizing waste biomass to produce biofuels while using the byproducts of the process as soil improvement additive. We have utilized a synchrotron radiation source to understand the mechanisms of biomass pyrolysis by conducting X-ray tomography studies. We have also collaborated with USDA to understand how this technology can be used to improve soil quality, decrease pesticide runoff and reduce water requirements for crop irrigation. In addition to biomass utilization, we are exploring the innovative concept of using waste concrete to achieve removal of air pollutants from power station. This breakthrough technology employs a recently discovered chemistry of waste concrete, where we demonstrated how to achieve a complete removal of NO_x and SO_x, which are priority air pollutants originating from power stations held responsible for health problems of millions of people worldwide. (DOT)



New Biomimetic Materials to Produce Hydrogen from Water

PI: Alexander Orlov, SBU

The future of clean hydrogen fuel based economy relies on producing hydrogen in a sustainable way. Currently, most of hydrogen is produced from fossil fuels and therefore cannot be considered sustainable. This project utilizes composite catalysts to combine light and water to synthesize sustainable hydrogen. We use some of the most innovative characterization techniques at Brookhaven National Lab, which are combined with theoretical modeling and experimental systems to produce novel catalysts with performance close to DOE targets for water splitting. This project is funded by the White House Office of Science Materials Genome Initiative, which fosters close integration of theoretical methods with

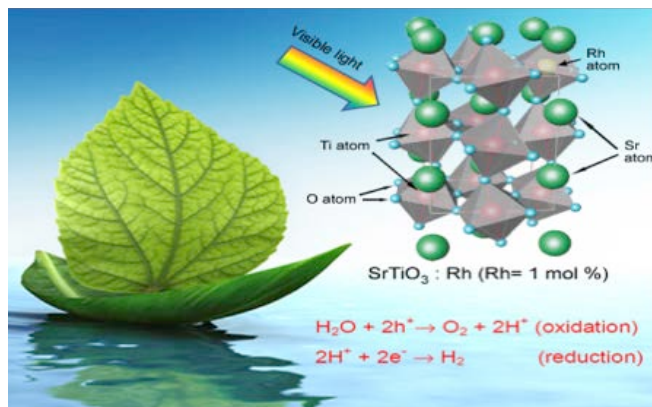

experiments to come up with novel materials with breakthrough performance. This collaborative project with Prof. John Parise (Geosciences) and Prof. Artem Oganov (Geosciences) is supported by the NSF grant "High-Pressure Synthesis of Novel Oxynitride Photocatalysts Directed by Theory and In Situ Scattering." (NSF)



Publication:
 N. Dharmagunawardhane, H. Woerner, Q. Wu, H. Huang, X. Chen, A. Orlov, P. Khalifah, J. Parise. *Photocatalytic hydrogen evolution using nanocrystalline gallium oxynitride spinel*, Journal of Materials Chemistry A, 2, 19247 (2014).

Assessment of Reforming the Energy Vision (REV) Projects

PIs: Devinder Mahajan, Eugene Feinberg, Jon Longtin (SBU); Thomas Butcher (BNL)

The Reforming the Energy Vision (REV) is an ambitious New York State initiative that is focused on reducing atmospheric CO₂ while providing a multitude of low-carbon technology options to customers. I-GIT is tasked with reviewing the effectiveness of such programs that are being managed by National Grid in New York. A formal report will be submitted under this contract. (National Grid, CIEES)

Publication:
 D. Mahajan, C. Xiaoli, D. Tonjes. *Energy Harvesting and Utilization Potential of Fugitive Methane with Climate Change Consequence*. Prog. Ener. & Comb. Sci., 56 33-70 (2016).

nationalgrid  CIEES
 CENTER FOR INTEGRATED
 ELECTRIC ENERGY SYSTEMS
 AT STONY BROOK UNIVERSITY

Developing Moderate Heterogeneous Catalytic Routes for the Conversion of Furan Derivatives into Chemicals and Liquid Hydrocarbon Fuels

PI: Tae Jin Kim, SBU

The energy consumption data provides that global energy production and consumption rely heavily on coal for electrical power and oil for transportation fuels. However, concerns with depletion of fossil fuels, especially petroleum oil, fluctuating petroleum oil prices and environmental and political problems have led our society to search for renewable and sustainable energy sources, such as solar, wind, hydroelectric and biomass. Among them, biomass is the only source of carbon and liquid biofuels/chemicals that are considered carbon neutral since CO_2 is consumed by biomass regrowth. We fully analyzed the structure information of different biomass resources and standard lignocellulose compositions using the FTIR spectroscopic. (Figure 1) The investigated samples are considered as potential lignocellulosic resources for future biofuels production and biochemicals. To apply these resources as a new material, it is very important to understand a revolution of functional group during the catalytic and thermal decomposition reaction. We can successfully assign most fingerprint and functional group regions in the obtained infrared spectra and use them for further treated samples structure analysis. We have also investigated new chemical reaction pathways to produce a cost-effective biomass derived fuel and chemical. (Figure 2) We hypothesized that furfuryl alcohol oligomers can be used as an additive in fuel blending components and biodegradable plastics. In figure 2, Furfuryl alcohol (FA; $\text{C}_5\text{H}_6\text{O}_2$), which is industrially produced through conversion of furfural ($\text{C}_5\text{H}_4\text{O}_2$) derived from a selective dehydration of xylose ($\text{C}_5\text{H}_{10}\text{O}_5$), is one of the most important furan derivatives. Based on the preliminary experimental results, we expect several impacts on the current technology for the current biomass conversion reaction into chemicals and fuels.

1. Improved and developed catalysts will provide alternative ways to produce important chemicals and fuels from biomass derived furan derivatives.

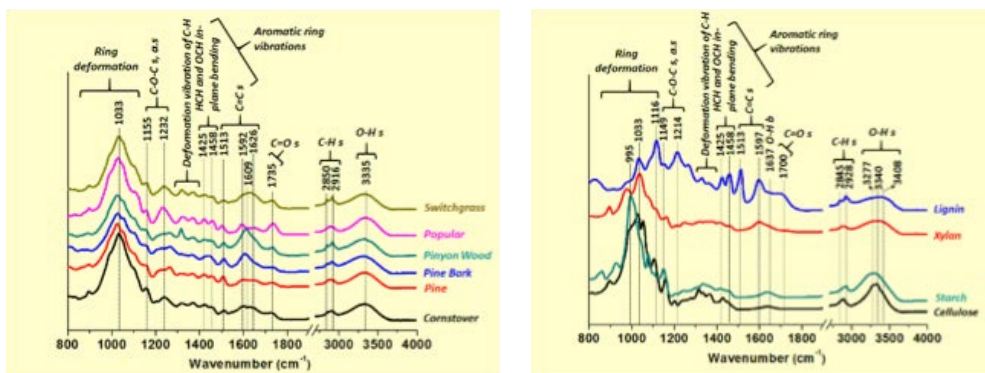

Figure 1. Infrared spectra of standard biomass resources.

2. Optimize the best formula with easy commercialization of the biofuel technology will decrease the dependence on traditional fossil fuel.
3. In addition to catalytic activity and selectivity investigation, in situ or Operando technique will provide the relationship between the heterogeneous catalysts structure and catalytic activity. (SBU)

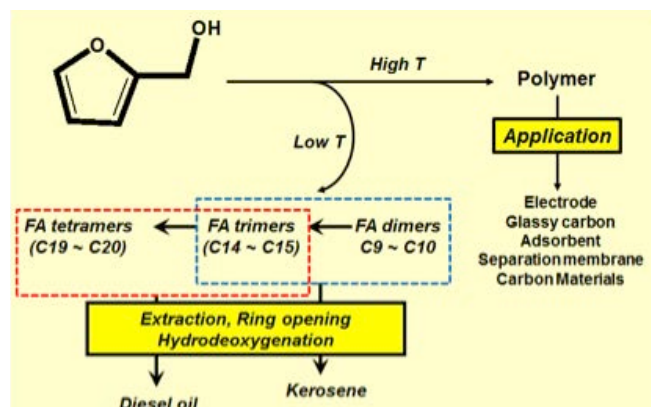

Figure 2. Proposed reaction pathways for conversion of furfuryl alcohol to chemicals and fuels.



Publications:
 T. Kim, J. Jeong, M. Rahman, E. Zhu, D. Mahajan. *Characterizations of Furfuryl Alcohol Oligomer/Polymerization Catalyzed by Homogeneous and Heterogeneous Acid Catalysts* KJCE, accepted (2014).
 T. Kim. *Biomass-based Nanocomposites and Mesoporous Materials* J. Nanotech Smart Materials 1 1-2 (2014).

BIOENERGY AND BIOFUELS

Development of Novel Materials for CO₂ Conversions into Fuels

PI: Alexander Orlov, SBU

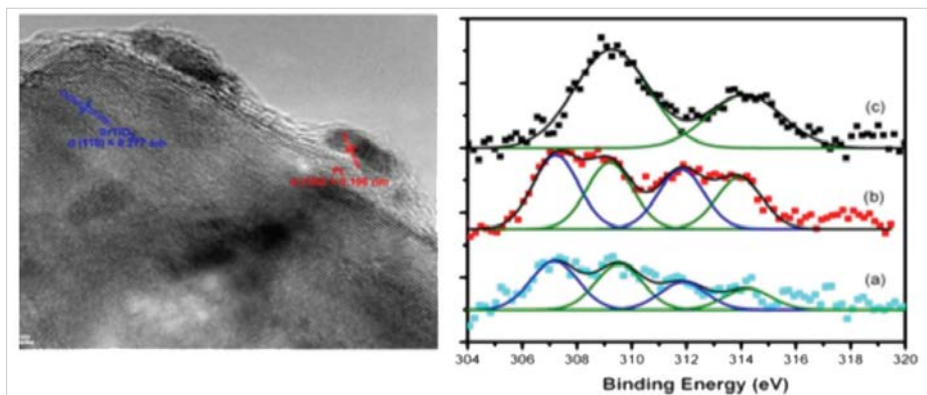

In this project, we are working to achieve a breakthrough and paradigm shift in how CO₂, a greenhouse gas, can be used to produce fuels. Nature achieves those conversions via photosynthesis by combining light, CO₂ and very sophisticated biochemistry. However, the quantum efficiency of this process is rather low. In our project we mimic the natural photosynthetic processes by using inorganic

catalysts with the eventual goal to make it more efficient than the naturally occurring processes. (NSF)



Publication:
P. Shen, J.C. Lofaro, W. Worner, M.G. White, A. Orlov.
Photocatalytic activity of hydrogen evolution over Rh doped SrTiO₃ prepared by polymerizable complex method, Chemical Engineering Journal, 223, 200–208 (2013).

Studying Catalysts Used for Energy and Environmental Applications Under Working Conditions

PI: Alexander Orlov, SBU

Heterogeneous catalysts often undergo dramatic changes in their structure as they mediate a chemical reaction. Multiple experimental approaches have been developed to understand these changes, but each has its particular limitations. In this collaborative project with the BNL Electron Microscopy group, we utilize unique TEM characterization techniques with exquisite spatial resolution while taking advantage of the recent developments in closed-cell microscopy methods. By measuring the catalysts' evolution under reaction conditions we develop unique mechanistic understanding of catalysts' activity and stability. (BNL)



Publication:
E. Stach, Y. Li, S. Zhao, A. Gamalski, D. Zakharov, R. Tapero, K. Chen-Weigart, J. Thieme, U. Jung, A. Elsen, Q.

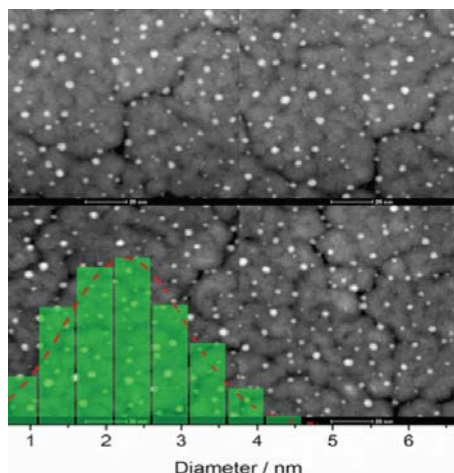

Wu, A. Orlov, J. Chen, R. Nuzzo, A. Frenkel. *Characterizing Working Catalysts with Correlated Electron and Photon Probes*, Microscopy and Microanalysis, 21, S3, 563-564, (2015).

Understanding Mechanistic Aspects of Biofuels Production

PI: Alexander Orlov, SBU

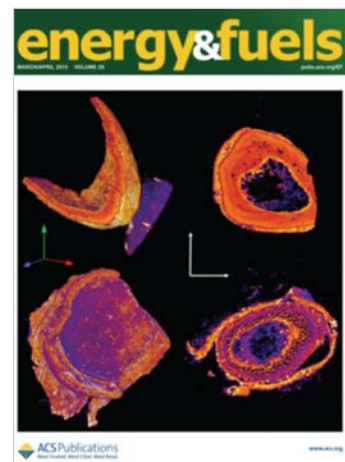

In this project we utilize nondestructive micrometer-scale synchrotron-computed microtomography (CMT) to study transformation of biomass in biofuels production. This project also utilizes SEM, EDX, and XRF characterization techniques, which allow us to develop a better understanding of evolution of biomass properties during its production, such as presence of metals and initial morphological features of biomass. These results have significant implications for utilizing resulting biochar as a soil additive and clarifying the mechanisms of biofuel production by pyrolysis. (USDA, BNL)



Publication:
K. Jones, G. Ramakrishnan, S. Uchimiya, A. Orlov, M. Castaldi, J. LeBlanc, S. Hiradate. *Fate of Higher-Mass Elements and Surface Functional Groups during the Pyrolysis of Pecan Shell*, Energy and Fuels, 29 (12), 8095–8101, Cover Article (http://pubs.acs.org/subscribe/covers/enfuem/enfuem_v029i003.jpg?0.9395697733853012) (2015).

Biomass Derived Furan/Furan Derivatives' Biofuel Products over Heterogeneous Catalysts

PI: Tae Jin Kim, SBU

Chemicals and fuels derived from lignocellulosic biomass are currently attracting attention and will serve as renewable source of carbon containing molecules. Although lignocellulose is one of the cheapest and abundant forms of biomass, due to its higher oxygen content, it is difficult to directly convert into transportation fuels. Mineral acids, such as H_2SO_4 and HCl, have been used to convert lignocellulose and furan derivatives into fuels and chemicals. However, due to the difficulty of catalyst separation and corrosion of reactor, the replacement of homogeneous catalyst to reusable heterogeneous solid catalyst is desirable. In addition to a heterogeneous catalyst development, it would require new catalytic route to improve the efficiency for conversion of biomass to fuels and chemicals. Our research group has been developing a novel pathway for Bio-kerosene and Bio-diesel oil from the biomass derived oxygenated chemicals;

1) Biomass-derived Furan Derivatives' Oligomer/Polymerization reaction

2) Hydrodeoxygenation (HDO) of Biomass Derived Oxygenates and Oligomers.

In order to analyze the products, we have been using the most advanced spectroscopic techniques (in situ Raman, FT-IR and UV-vis) and analytical instruments (GC and GC/MS). We will continuously investigate and determine the product distributions of furan derivatives dimers (C9-C10) and trimer (C10-C15), and employed density functional theory to provide a qualitative confirmation of the experimentally observed oligomer distribution trends.

The overall objectives of our current research projects are:

- To produce biodiesel from furanic oligomers.
- To develop a novel heterogeneous catalysts which avoid a separation issue from product.

- To provide catalyst surface structure evolution and intermediate species by using the spectroscopic techniques.
- To develop thermochemistry and reaction mechanism based on the density functional theory (DFT) calculation (collaboration team: Argonne National Laboratory Theory Team). (SBU)



Publications:

T. Kim, R.S. Assary, R.E. Pauls, C.L. Marshall, L.A. Curtiss, P.C. Stair, *Thermodynamics and Reaction Pathways of Furfuryl Alcohol Oligomer Formation*, Catal. Commun., 46 66-70 (2014).
T. Kim, R.S. Assary, Hacksung Kim, C.L. Marshall, D.J. Gosztola, L.A. Curtiss, P.C. Stair, *Effects of solvent on the furfuryl alcohol polymerization reaction: UV Raman spectroscopy study*, Catal. Today 205 60-66 (2013).
T. Kim, R.S. Assary, C.L. Marshall, D.J. Gosztola, L.A. Curtiss, P.C. Stair, *Studies of the Raman Spectra of Cyclic and Acyclic Molecules: Combination and Prediction Spectrum Methods*, Chemical Physics Letters, 531 210-215 (2012).
T. Kim, R.S. Assary, C.L. Marshall, D.J. Gosztola, L.A. Curtiss, P.C. Stair, *Acid-Catalyzed Furfuryl Alcohol Polymerization: Characterizations of Molecular Structure and Thermodynamic Properties*, ChemCatChem, 3 1451-1458 (2011).

Biogas Management for Power and Transportation Fuels Production

PIs: Devinder Mahajan, SBU;
Chai Xiaoli, Tongji University

In July 2013, the NSF funded Center for Bioenergy Research and Development (CBERD) at SBU signed an agreement with Tongji University, China to jointly develop technologies to economically convert biogas from landfills and other sources to transportation fuels. The Partnership will design effective systems for generation and management of biogas from solid waste facilities. The project will use a suite of technologies tested by CBERD at the Town of Brookhaven landfill; including upcoming gas-to-liquid conversion technologies to produce fungible liquid fuels. The follow-up tests will be conducted at the Shanghai Laogang landfill in Shanghai – one of the largest landfills in China. The project will be monitored by the joint EcoPartnership secretariat and the project progress will be reported annually during an event during the high-profile US-China Strategic and Economic Dialog (S&ED) hosted by the U.S. Department of State (Ministry of Science and Technology (MoST), China).



ECO PARTNERSHIPS



Publication:

D. Mahajan, *Preface to Special Topic: Low-Carbon Pathways Toward Decarbonizing Economy in Asia Pacific*, 9, 021301; doi: 10.1063/1.4978466 (2017).

RESEARCHER PROFILE



Energy Projects:
Low-Carbon Energy
Technologies
Distributed Fuel and
Power Production

Devinder Mahajan, Professor, Chemical & Molecular Engineering, Stony Brook University & Director, Institute of Gas Innovation and Technology

Awards and Honors:

- Member Inductee, National Academy of Inventors, Washington DC (2018)
- High-End Foreign Expert, Energy & Environment, SAFEA, Beijing, China (2015-17)
- Jefferson Science Fellow, Department of State, Washington DC (2011-17)
- Marie Curie Researcher of Biomass Valorization, Joint European Commission (2013-17)
- Certificate of Recognition, Bureau of Energy Resources, US Department of State (2012)
- Fulbright Specialist Scholar, Asian Institute of Technology, Thailand (2010)
- Outstanding Mentor Award, United States Department of Energy (2007; 2009)
- Fellow, Agency of Industrial Science and Technology (AIST), Tsukuba Science City, Japan (1997)

Development of Nanocatalysts for Fuels from CO₂-Enriched Syngas using a Si-Microreactor

PIs: Devinder Mahajan, SBU and Debasish Kulia, NC A&T

The objectives of our CREST Partnership is to: 1) conduct fundamental research on conversion technology using CO₂-enriched syngas as feedstock for efficient and economic production of liquid transportation fuels, in collaboration with the Advanced Energy Research and Development Center (AERTC) at Stony Brook University (SBU).

Our goal is to: 1) develop new materials for catalytic conversion of H₂/CO/CO₂ mixture into fuels using Si-microchannel microreactors (SiMM). This work complements our ongoing research on conversion of syngas to biofuel using novel nanocatalysts encapsulated in high surface area mesoporous supports, 2) provide education and training for under-represented undergraduate and graduate students, 3) serve as a pipeline for K-12, community college, undergraduate, and graduate students into bioenergy related STEM disciplines and careers. (NSF)



Publication:
C. Okoli, K. A. Kuttijiel, J. Cole, J. McCutchen, H. Tawfik, R. Adzic, D. Mahajan, *Sonochemical synthesis of metal alloy nanoparticles in different solvents for use as electrocatalysts*. Ultrason. Sonochem., submitted (2017).

A Simple Approach to Prepare Carboxycellulose Nanofibers from Untreated Biomass

PI: Benjamin S. Hsiao, SBU

Carboxycelluloses are important derivatives of natural cellulose polymers, and they have been widely used in many biomedical applications, such as hemostatic materials and surgical sutures. Recently, the developments of different methods to produce carboxycelluloses in nanoscale, such as nanofibers or nanospheres, have further expanded their usage in existing and emerging applications, such as water purification, nanocomposites, nano-paper, drug delivery, ultra-porous lightweight foams and aerogels, gas barrier films, biomaterials, stability enhancers for carbon nanotube dispersions, etc. Many other forms of nanocelluloses without carboxyl groups, such as cellulose nanocrystals, microfibrillated cellulose, bacterial nanocellulose and cellulose nanofibers, have also been extensively studied in the literature.

The major features of carboxycellulose nanofibers, which can be referred to as functional nanocelluloses, are two: (i) the nanoscale format is resulted from the existence of building blocks – cellulose microfibrils, – in the cell walls of biomass, rather than by regeneration of dissolved cellulose polymer chains requiring energy-intensive processes; (ii) the modification, such as by TEMPO oxidation, carboxymethylation, phosphorylation, acetylation, and silylation, on the nanocellulose surface introduces negative charges, which not only facilitate nanofiber dispersion in suspensions, but also provide functional sites for utilization (e.g. adsorption) and further chemical reaction. In addition, nanocelluloses can be extracted from any biomass, including underutilized sources, such as grasses, weeds, shrubs and agricultural waste.

Thus, the development of environmentally friendly and low energy means to extract carboxycellulose nanofibers, from low valued biomass, has untapped potential to replace synthetic polymers in many applications, especially water purification. This is because carboxycellulose nanofibers can offer very large surface area and functional groups, ideally suited as filtration membranes or/and adsorption media for water treatments.

A simple approach was developed to prepare carboxycellulose nanofibers directly from untreated biomass using nitric acid or nitric acid-sodium nitrite mixtures. Experiments indicated that this approach greatly reduced the need for multi-chemicals, and offered significant benefits in lowering the consumption of water and electric energy, when compared with conventional multiple-step processes at bench scale (e.g. TEMPO oxidation). Additionally, the effluent produced by this approach could be efficaciously neutralized using base to produce nitrogen-rich salts as fertilizers. TEM measurements of resulting nanofibers from different biomasses, possessed dimensions in the range of 190-370 and 4-5 nm, having PDI=0.29-0.38. These nanofibers exhibited lower crystallinity than untreated jute fibers as determined by TEM diffraction, WAXD and 13C CPMAS NMR (e.g. WAXD crystallinity index was ~35% for nanofibers vs. 62% for jute). Nanofibers with low crystallinity were found to be effective for removal of heavy metal ions for drinking water purification. (NSF)

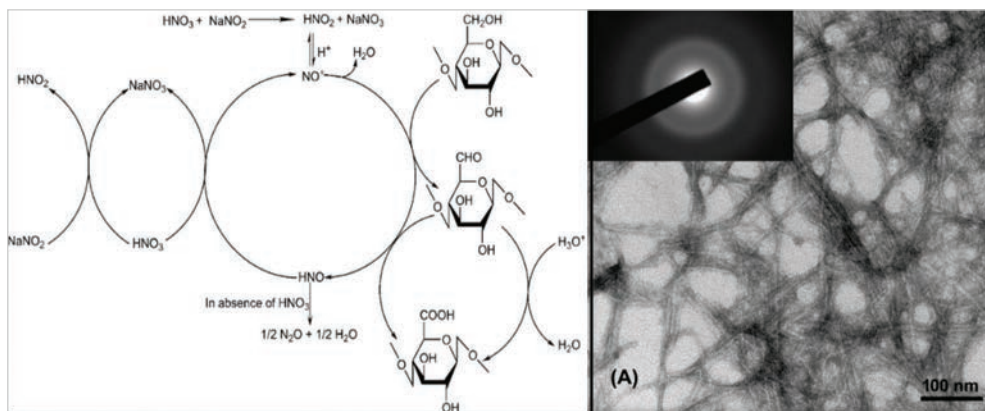

Nanotoxicology of Particles Commonly Used for Energy Applications: A Collaboration Between the AERTC and the School of Dental Medicine

PI: Miriam Rafailovich, SBU

Titanium dioxide (TiO_2), or titania, is naturally occurring compound that has several polymorphs, the most common being Rutile and Anatase, with the same chemical formula but different crystalline structures. TiO_2 particles are well known UV absorbers, emitting energetic electrons when irradiated. Consequently, they are important components in solar cell design for power generation. Reactive ion species (ROS) products which are formed when TiO_2 is exposed to UV radiation have long been known to be effective as anti-bacterial as well as an anti-cancer agents. The first study of anti-cancerous activity of TiO_2 nanoparticles in human cervix adenocarcinoma (HeLa) cells was performed in the early 1990s and showed that HeLa cells could be effectively destroyed by TiO_2 upon short irradiation with UV light. Within a decade, the effectiveness of TiO_2 in combination with UV light as an anti-cancerous agent, was confirmed by multiple groups in different cancer models. The efficacy of TiO_2 and UV light against Gram-negative and Gram-positive bacteria was reported even earlier, and today TiO_2 is commonly used to amplify the efficiency of UV light in water purification and sterilization of medical instruments.

TiO_2 is also commonly used in multiple consumer products colorants. The high refractive index of TiO_2 for visible light imparts it with a high brightness white color, and since the particles are considered "safe" they account for 70 % of the total production volume of pigments worldwide. Roughly four million tons of TiO_2 (nano and bulk combined) are used for annual production of paints, coatings, plastics, inks, paper, pharmaceuticals, cosmetics, toothpastes, medicines, sunscreens and food products, bringing TiO_2 NPs to the top five nanoparticles (NPs) used in consumer products and photovoltaics. Recently, though, multiple reports (including from our group) have appeared which demonstrate that TiO_2 NPs exhibit immediate toxicity to human cells. In fact, the International Agency for Research on Cancer has recently classified the TiO_2 particles as "a possibly carcinogenic to humans". Hence, even though in the bulk, titania is non-toxic, when reduced

to nanoscale dimension, it is currently a significant hazard for industrial workers in plants producing photovoltaic or pigmented products. Recently, research is showing that the particles also pose a significant health risk to consumers and hence should be re-classified. The detrimental effect of these particles is well understood in terms of reactive ion species formed, which are toxic to both eukaryotic cells and bacteria when the photoelectron is emitted after irradiation of TiO_2 particles. Yet, in the absence of UV irradiation, TiO_2 is reported to be toxic primarily to eukaryotic cells and not to bacteria. This can be a cause of possible concern, especially when the cells exposed to particles are also exposed to bacteria, such as in the oral cavity where these particles are used in oral care products and food. Hence, newly emerging research as part of the collaboration between scientists at the AEC and the SDM indicates that these particles may greatly enhance the risk of bacterial infection in humans. On one hand, human skin and endothelium cells exposed to TiO_2 nanoparticles, in the absence of light, are many more times more likely to be infected by bacteria, while exposure to these particles significantly depresses the ability of phagocytes, human immune system cells, to fight bacterial infection.

While some particles are detrimental, multiple particles currently being used for energy applications, such as functionalized clays and graphene have been shown to have beneficial effects in stem cell differentiation and bioremediation. The AEC is firmly committed to ethical research practice where technological advances and their impact on human health are continuously being monitored and investigated. Hence research at the AEC is a continuing collaboration between engineering and health professionals to define the interactions of modern technological advances with human biology. (NSF)

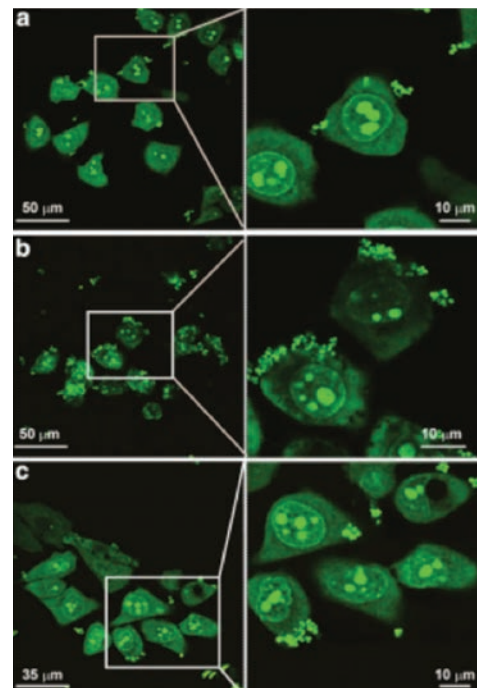

Confocal microscopy pictures of HeLa control cells (a) and cells exposed to 0.1 mg/ml anatase (b) and rutile TiO_2 (c) followed by exposure to *S. aureus* bacteria. The cells and bacteria were both stained green by SYTO 9. Arrows point to bacteria (green dots)

References:
Y. Xu, M. Tzo Wei, H. Daniel, O. Yang, S. G. Walker, H. Z. Wang, C. R. Gordon, S. Guterman, E. Zawacki, E. Applebaum, P. R. Brink, M. Rafailovich, T. Mironava. *Exposure to TiO_2 nanoparticles increases Staphylococcus aureus infection of HeLa cells.*
Z. Pan, W. Lee, L. Slutsky, R. Clark, N.M. Pernodet, M. Rafailovich. *Adverse effects of titanium dioxide nanoparticles on human dermal fibro blasts and how to protect cells.* Small;5(4):511–20 (2009).

Investigation of the Catalytic Activity for CO Oxidation on Boron Nitride Nanotubes (BNNTs)

PI: Tae Jin Kim, SBU

Boron nitride nanotubes (BNNTs), which are structurally similar to carbon nanotubes (CNTs), have recently attracted increased attention due to their various potential applications (e.g. electronic, mechanical, and optical devices). Despite of huge potentials of BNNTs, they have not been much applied in catalysis research areas except for the theoretical calculation. The goal of the proposed research is to fully investigate the BNNTs supported (modified and unmodified) metal (and metal oxide) catalysts and to provide the structure-activity-selectivity relationship during the CO oxidation reaction as a case study. (Sensor CAT, NAI EEL Technology)

Sensor CAT
CENTER FOR ADVANCED TECHNOLOGY
IN SENSOR SYSTEMS

AT STONY BROOK UNIVERSITY  www.nai.eel.com



*BNNT research capabilities

Catalytic Activity of Cu/CHA on the NH₃-SCR Reaction

PI: Tae Jin Kim, SBU

NO_x is the common term for mono-nitrogen oxides (NO and NO₂), which are exhausted from automobiles and stationary sources during combustion (fossil fuels in vehicles' engines or coal in electric power plants). Recently, Cu based zeolite especially Chabazite, CHA (Cu-CHA) has been selected for selective catalytic reduction (SCR) applications because it showed exceptional hydrothermal stability in addition to the higher NO reduction activity. In this research, Cu/CHA catalysts with various Cu loadings (0.5wt%~6.0wt%) were synthesized via incipient wetness impregnation and were applied to the SCR of NO with NH₃ and NO oxidation reaction. XRD and N₂ adsorption/desorption data showed that CHA structure is maintained with the incorporation of Cu (Figure 1), while specific surface areas decreased with increasing Cu loading. At intermediate Cu loading, 4 wt%, the highest NH₃-SCR activity was observed with ~98% N₂ selectivity from 150°C to 300°C. (Figure 2) Small amounts of water, 2%, slightly increased NO conversion in addition to the remarkable N₂O and NO₂ reduction at high temperature. Water effects are attributed to the improved Cu ion reducibility and

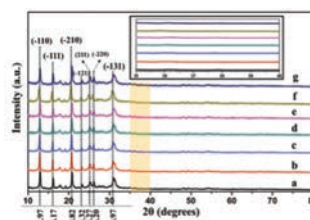

Figure 1. XRD patterns of a) CHA, b) 0.5% Cu/CHA, c) 1% Cu/CHA, d) 2% Cu/CHA, e) 4% Cu/CHA, f) 5% Cu/CHA, and g) 6% Cu/CHA samples. Inset: XRD patterns between 35 and 40°.

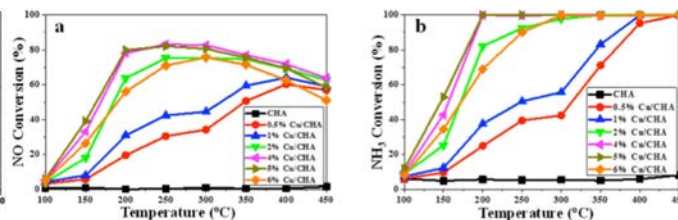

Figure 2. a) NO Conversion as a function of temperature over Cu-CHA, b) NH₃ Conversion as a function of temperature over Cu-CHA during NH₃-SCR on Cu-CHA. Reaction conditions: 50 ml/min (500 ppm) NO, 50 ml/min (500 ppm) NH₃, 10% O₂ balanced with Ar, total flow rate 200ml/min. ~40 mg sample is used.

mobility. NO oxidation results provided no relation between NO₂ formation and SCR activity. Physicochemical properties, NO conversion, N₂ selectivity, and activation energy data showed that impregnated samples' molecular structure and catalytic activity are comparable to the conventional ion-exchanged (IE) samples' ones. (SBU, BNL)

Publication:
N. Akter, X. Chen, J.B. Parise, J.A. Boscoboinik, T. Kim. *Effects of Copper Loading on the NH₃-SCR and NO oxidation over Cu impregnated CHA framework zeolite by the Incipient Wetness Method* Korean J. Chem. Eng., 35(1), 89-98 (2018).

BATTERY AND STORAGE RESEARCH

Multimodality X-ray Imaging at Nanometers

Pls: Yong Chu, BNL, Esther S. Takeuchi, SBU and BNL, Amy C. Marschilok and Kenneth J. Takeuchi, SBU

Powerful x-ray imaging capabilities, currently being developed at the Hard X-ray Nanoprobe (HXN) at the National Synchrotron Light Source II (NSLS-II), are opening new scientific opportunities for investigating complex nanostructures with unprecedented sensitivity and resolution. These multimodality imaging capabilities allow simultaneous visualization of interfacial morphology, elemental distribution, and disturbance of crystalline lattice. They are ideally suited for examining how complex interfaces of battery materials are transforming during electrochemical reactions. In close collaboration with the HXN team, Takeuchi Group is aiming at gaining a mechanistic understanding of electrode transformation due to Li⁺ insertion and redox of Ag⁺ cation in systems such as silver vanadium phosphorous oxides (SVPO) and silver hollandite. The figure below illustrates how the HXN fluoresce

x-ray imaging capability was to visualize Ag phase separation from a single crystalline SVPO matrix with a spatial resolution of 15 nm. With commissioning of additional imaging modalities, it will be possible to image disturbance of crystalline lattice due to Li⁺ and reduction of Ag⁺ cations, providing comprehensive structural details. (BNL)

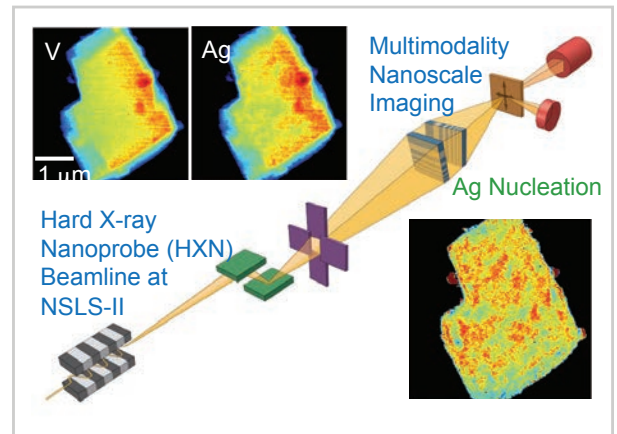

Multifunctional Cathode Additives for Li-S Battery Technology

Pls: Hong Gan, BNL, Esther S. Takeuchi, SBU and BNL, Amy C. Marschilok and Kenneth J. Takeuchi, SBU

The state of the art Li-ion batteries are approaching their limit in energy density and power capability as determined by the lithium metal oxide cathode and the graphite anode based chemical systems. Although adequate for most mobile electronic devices, the calls for battery technologies with higher energy density and lower cost is urgent for other applications especially in the area of transportation, such as electric vehicle. Li-S battery technology is considered to be one of the most promising future technology that could result in double or triple the energy density over today's best Li-ion batteries, while still achieve the lower cost target due to the abundance of the sulfur element on the earth crust. The major challenges that prevent today's Li-S battery technology for commercialization are the reduced chemical stability, low power capability and low cycle life, which are strongly associated with the complicated reaction mechanism and the dissolution of the reaction intermediates.

Our team is focusing on the development of the next generation sulfur battery technology by introducing capacity contributing conductive cathode additives to the sulfur cathode. Mechanistic investigation of the system at the components and cell level enables us to better understand the chemical and electrochemical behavior of each material as well as the strong interaction between multiple cell components (see publication). Improved cell cycling performances and power capability are achieved by proper selection of the cathode additive. Sulfur and TiS₂ hybrid cathode showed improved cycle life under 1C rate discharge (C/5 at every 51st cycle; see Figure) over more than 300 cycles. The learning from these studies paves the pathway for additional Li-S battery system improvement and optimization. (DOE)

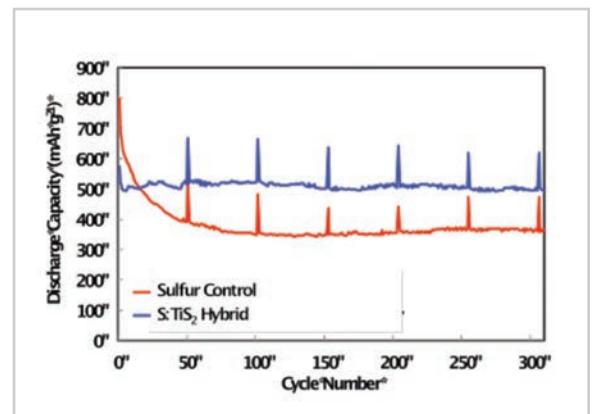

Publication: K. Sun, S. Dong, Q. Zhang, D. Bock, A. Marschilok, K. Takeuchi, E. Takeuchi, H. Gan, *Interaction of CuS and Sulfur in Li-S battery system*. J. Electrochem. Soc., 162 (14) A1-A6, (2015).

BATTERY AND STORAGE RESEARCH

High Capacity Anode Investigation

PI's: Esther S. Takeuchi, SBU and BNL,
Amy C. Marschilok and Kenneth J. Takeuchi, SBU

Increasing battery energy density remains an important challenge to enable widespread adoption of electric vehicles. However, increasing energy density requires new materials. Implementation of new materials demands new fundamental understanding of the material and its electrochemistry prior to implementation. The Advanced Power Sources Laboratory provides comprehensive capabilities in power source research, characterization, evaluation, and testing. State-of-the-art equipment and software are available to perform a wide variety of research activities for almost any primary or rechargeable technology. Multidisciplinary in nature, the research involves aspects of inorganic chemistry, electroanalytical chemistry, materials science and engineering, and physics. Three state-of-the-art facilities, located at the Advanced Research and Technology Energy Center and the Chemistry building at Stony Brook and in the Interdisciplinary Science Building at Brookhaven National Laboratory, were custom-designed for the group's research. The proximity of Stony Brook University to Brookhaven National Labora-

tory facilitates access to the advanced characterization capabilities located there.

Mercedes-Benz Research Development North America (MBRDNA) is supporting to the Stony Brook University Advanced Power Sources Laboratory to enable basic research advancing alternative high capacity anode materials for lithium ion type batteries. Mercedes-Benz is consolidating all activities in connection with electric mobility under the new product brand EQ, and the Concept EQ gives a clear outlook onto a completely new generation of vehicles. Mercedes-Benz Cars plans to launch more than ten electric vehicles by 2025: in all segments from smart to large SUVs. (Mercedes-Benz Research & Development, North America through the Stony Brook University Foundation)

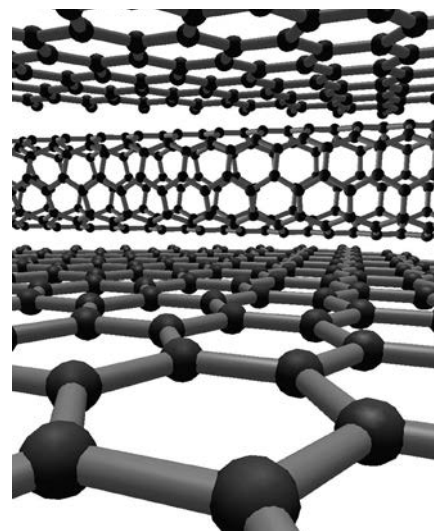

Carbon Nanomaterials for High Performance Supercapacitors

PI: Vladimir Samuilov, SBU

Our research focuses on carbon nanomaterials for supercapacitors as high-performance energy storage devices for a large variety of potential applications from consumer electronics through wearable optoelectronics to hybrid electric vehicles. Nanocarbons come in a wide variety of forms and their properties are very dependent on their structures and morphology. The effort here will focus on fabrication of different forms of hybrid films of nanocarbon, like carbon nanotubes, 3-D graphene and reduced graphene oxide. The combination of these forms of nanocarbon increases the electrode specific surface area and provides excellent electrical and mechanical properties. We have developed a simple approach to lower the equivalent series resistance of supercapacitors by fabricating electrodes using highly concentrated solutions of carbon nanotubes and reduced graphene oxide based composites. (SUNY RF, Local Industry, Sensor CAT)



Types of Government Supports in Energy Technology Innovation: The Case of Li-ion Battery Technologies

PI: Guodong Sun, SBU

The objective of this study is to understand the impacts of different types of government supports (e.g. government championship, technological support and financial aid) on technology innovation process. Lithium-ion (Li-ion) battery technology has experienced significant progress in recent years. Especially for the application on electric vehicle, Li-ion battery is considered as one of the most promising technologies. In addition to enormous efforts by the private firms, governments have also invested heavily in this area, notably in several countries including the United States. It is an excellent case to examine. To what extent and how, government support contributes to the progress

of advanced energy technologies? We are surveying the project managers or principle investigators of about 700 Li-ion battery R&D projects that have received supports from federal government. A value of this research is that its findings can be used to improve government R&D policy. (SBU)



BATTERY AND STORAGE RESEARCH

Workload-Aware Storage Architectures for Optimal Performance and Energy Efficiency

PIs: Erez Zadok and Arie Kaufman, SBU

The most significant performance and energy bottlenecks in a computer are often caused by the storage system because the gap between storage device and CPU speeds is greater than in any other part of the machine. Big data and new storage media only make things worse because today's systems are still optimized for legacy workloads and hard disks. The teams at Stony Brook University, Harvard University and Harvey Mudd College have shown that large systems are poorly optimized, resulting in waste that increases computing costs, slows scientific progress and jeopardizes the nation's energy independence. First, the team is examining modern workloads running on a variety of platforms, including individual computers, large compute farms and a next-generation infrastructure, such as Stony Brook's Reality Deck, a massive gigapixel visualization facility. These workloads produce combined performance and energy traces that are being released to the community. Second, the team is applying techniques such as statistical feature extraction, Hidden Markov Modeling, data-mining and conditional likelihood maximization to analyze these data sets and traces. The Reality Deck is used to visualize the resulting multi-dimensional performance/energy data sets. The team's analyses reveal fundamental phenomena and principles that inform future designs. Third, the findings from the first two efforts are being combined to develop new storage architectures that best balance performance and energy under different workloads when used with modern devices, such as solid-state drives (SSDs), phase-change memories, etc. The designs leverage the team's work on storage-optimized algorithms, multi-tier storage and new optimized data structures. (NSF)

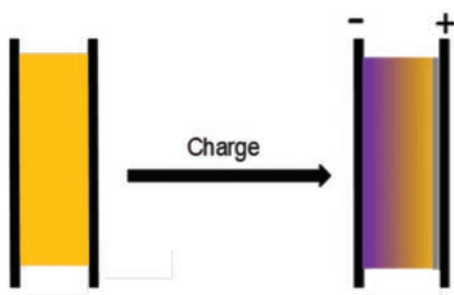

Dual Function Solid State Battery with Self-Forming Self-Healing Electrolyte and Separator

PIs: Esther S. Takeuchi, SBU and BNL, Amy C. Marschilok and Kenneth J. Takeuchi, SBU

Lithium based battery systems are attractive due to their high energy densities, however, safety issues resulting from the organic electrolyte and dendritic lithium formation are major concerns. Solid state electrolytes provide an opportunity to replace the conventional liquid flammable electrolyte. Self-forming batteries can be envisioned where the anode and cathode are formed upon charge from a single solid electrolyte. The Li/I₂ couple is an attractive target due to its high energy density and opportunity to self-heal. Notably, the primary Li/I₂ battery has been a successful technology as the power source for implantable cardiac pacemakers. The objective of this project is to demonstrate a solid state rechargeable battery based on lithium metal (Li) and iodine (I₂) cathode with a self-healing electrolyte and separator. The resulting rechargeable self-assembled metal/iodine solid state battery will provide high energy density. This study will contribute to the future development of high energy density solid state self-forming, self-healing, solid-state, safe and reliable rechargeable batteries. (DOE-EERE)



Sulfur Loaded MS₂ Barrier for Control of Polysulfide Shuttling in Lithium Sulfur Batteries

PIs: Esther S. Takeuchi, SBU and BNL, Amy C. Marschilok and Kenneth J. Takeuchi, SBU

The goal of this project is to demonstrate a novel sulfur rich two-dimensional (2-D) nanosheet MS₂ (M= Mo, Ti) composite lithium-sulfur battery system with high capacity (high sulfur loading) and capacity retention (decreased polysulfide dissolution). This will be achieved by a novel electrode construction based on 2-D MS₂/S₈ which will overcome limitations of sulfur's low electronic conductivity and parasitic reactions that result from polysulfide dissolution during charge/discharge process that shorten the cycle life and reduce capacity. The high theoretical energy density of the Li/S couple provides an opportunity to reach Department of Energy goals of high energy density and long cycle life for vehicle technology, resulting in electric vehicles with a long range and long life battery system.

The proposed Li/S battery concept utilizes 2-D-nanosheet transition metal dichalcogenides (MS₂, M = Mo, Ti), to capitalize on the positive transition metal center, to facilitate the trapping of negatively charged polysulfide chains before entering bulk solution to reduce polysulfide shuttling. Sulfur will be embedded between the MS₂ nanosheets to create a 2-D-MS₂/S₈ composite cathode, which will enable high sulfur loading in cathode and enhanced material homogeneity by the inclusion of 2-D nanosheets. (DOE-EERE)

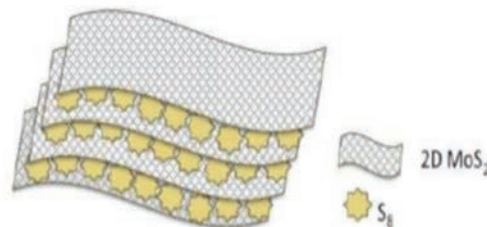

BATTERY AND STORAGE RESEARCH

Nanomaterials and Nanostructures for Energy Storage Applications

PI: Vladimir Samuilov, SBU

We have developed a number of technologies for nanomaterials: Carbon Nanotube and Graphene 2-D and 3-D structures, metal and dielectric thin films deposition and processing (amorphous C, diamond-like carbon, Si, SiC, different metals), CVD, thermal, plasma deposition and etching. These technologies are used in energy storage applications (batteries and supercapacitors) and nano- and bio-sensors. We also developed state-of-the-art testing facilities for sensors and electrical energy storage systems.

We are open for collaboration with the members of the Advanced Energy Center interested in these applications of the nanomaterials for energy storage and sensors. (Sensor CAT)

Sensor CAT
CENTER FOR ADVANCED TECHNOLOGY
IN SENSOR SYSTEMS

AT STONY BROOK UNIVERSITY

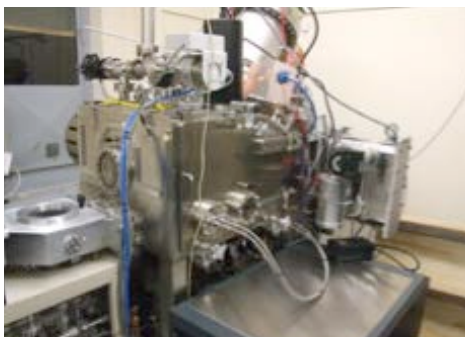

In-situ and In-operando Analysis of Energy Storage Materials

PIs: Esther S. Takeuchi, SBU and BNL,
Amy C. Marschilok and Kenneth J. Takeuchi, SBU

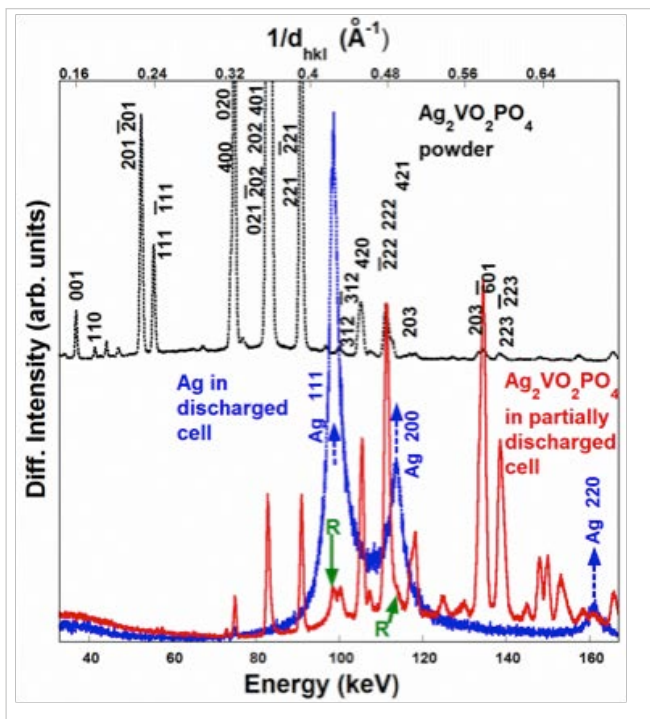

In situ methods can allow direct interrogation of a battery electrode in its native environment, without exposure of the surfaces to ambient air, moisture and other reactive and deleterious substances. In operando analysis can illuminate changes occurring within a battery material under real use conditions. Such measurements require an understanding of the use conditions of the battery coupled with the ability to collect the data under controlled environments.

For example, crystallographic in situ analysis of electroactive material can provide insight into the material reduction mechanism with the confidence that no structural change or decomposition occurred as a result of material removal from the cell or post-processing. At the National Synchrotron Light Source (NSLS) at Brookhaven National Laboratory, the formation of silver metal from the reduction of $\text{Ag}_2\text{VO}_2\text{PO}_4$ can be clearly observed at the electrode-electrolyte interface within

a lithium- $\text{Ag}_2\text{VO}_2\text{PO}_4$ electrochemical cell, where the progression of the reduction reaction through the thickness of the cathode can be monitored. This insight amplifies the point that full understanding of an electrochemical reaction in an active battery requires knowledge of the material status as a function of location within the cathode as well as the overall properties of the cathode material. (DOE)



Publication:
E. Takeuchi, A. Marschilok, K. Takeuchi, A. Ignatov, Z. Zhong, M. Croft. *Energy dispersive X-ray diffraction of lithium-silver vanadium phosphorous oxide cells: in situ cathode depth profiling of an electrochemical reduction-displacement reaction.* Energy and Environmental Science. 6, 1465-1470 (2013).

BATTERY AND STORAGE RESEARCH

Improved Batteries for Implantable Cardiac Defibrillators

PIs: Esther S. Takeuchi, SBU and BNL,
Amy C. Marschilok and
Kenneth J. Takeuchi, SBU

There is an ever growing demand for implantable cardiac defibrillators (ICDs), with over 100,000 devices implanted in 2004, and dramatic increases anticipated over the next decade due to expanded indications and coverage by Medicare. The growing level of acceptance of these life-saving devices has increased the desire for improved ICD function. The lifetime of the average ICD patient after implant has increased to 10 years while the average device lifetime is around 5 years. Thus, most patients require additional surgeries to replace their original device, resulting in both clinical risk and cost.

The overall project goal is to solve this discrepancy with fundamental science by demonstrating new superior cathode materials that could be used to extend the life and improve the consistency of ICD batteries. The proposed project has three specific objectives:

- 1) develop a new class of improved battery materials for ICD applications,
- 2) test the materials in experimental batteries under simulated use schemes mimicking ICD function, and

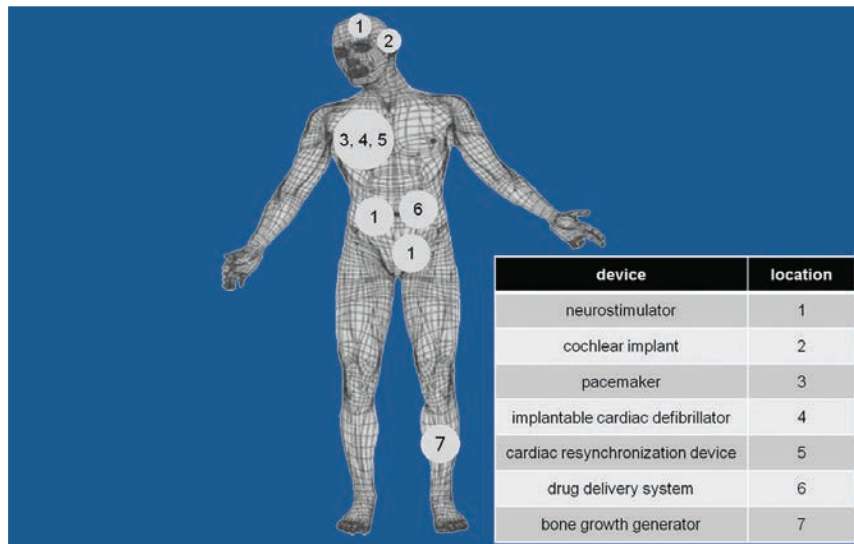

- 3) compare the key characteristics of long term stability, energy delivery, and energy content with the current battery benchmark technology. (NIH)



Publications:

E. Takeuchi, A. Marschilok, K. Tanzil, E. Kozarsky, S. Zhu, K. Takeuchi. *Electrochemical reduction of silver vanadium phosphorous oxide, Ag₂VO₂PO₄: The formation of electrically conductive metallic silver nanoparticles.* Chemistry of Materials. 21(20), 4934-4939. PubMed ID: 20161435 (2009).

A. Marschilok, E. Kozarsky, K. Tanzil, S. Zhu, K. Takeuchi, E. Takeuchi. *Electrochemical reduction of silver vanadium phosphorous oxide, Ag₂VO₂PO₄: Silver metal deposition and associated increase in electrical conductivity.* Journal of Power Sources. 195(19), 6839-6846. PubMed ID: 20657813 (2010).

Y. Kim, C. Lee, A. Marschilok, K. Takeuchi, E. Takeuchi. *Ag_xVOPO₄: A demonstration of the dependence of battery-related electrochemical properties of silver vanadium phosphorous oxides on Ag/V ratios.* Journal of Power Sources. 196(6), 3325-3330. PubMed ID: 21318071 (2011).

D. Bock, A. Marschilok, K. Takeuchi, E. Takeuchi. *Batteries used to power implantable biomedical devices.* Electrochimica Acta. Available online. <http://dx.doi.org/10.1016/i.electacta.2012.03.057> (2012).

RESEARCHER PROFILE



Esther Takeuchi, William and Jane Knapp Endowed Chair in Energy and the Environment; Distinguished Professor of Chemistry in the College of Arts and Sciences and in Materials Science and Chemical Engineering in the College of Engineering and Applied Sciences; Director, m2M/t Energy Frontier Research Center; and Chief Scientist of the Energy Sciences Directorate at Brookhaven National Laboratory

Awards and Honors:

- Fellow, American Association for the Advancement of Science (AAAS), 2018
- European Inventor Award in the "non-EPO countries" category, presented by the European Patent Office (EPO), 2018
- Charter Member, National Academy of Innovation (2013)
- E.V. Murphree Award, American Chemical Society (2013)
- National Inventors Hall of Fame (2011)
- Recipient of National Medal of Technology and Innovation (2009)
- Astellas USA Foundation Award (2008)
- SUNY Distinguished Professor (2009)
- 140 issued US Patents

Energy Projects:
Energy storage
Portable power sources
Micro-power sources

BATTERY AND STORAGE RESEARCH

New Materials for Stationary Grid-Scale Energy Storage

PIs: Esther S. Takeuchi, SBU and BNL,
Amy C. Marschilok and
Kenneth J. Takeuchi, SBU

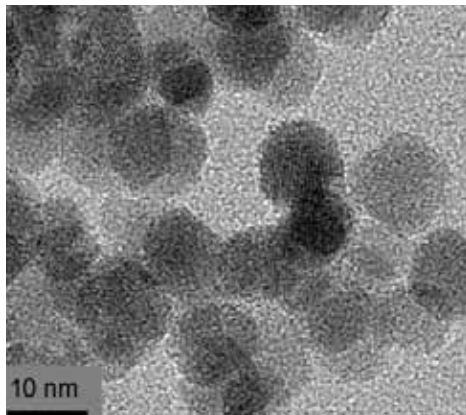

The vast majority of recent battery research investment has focused on the important problem of electrical energy storage for

transportation applications. The successes of these investments and electric vehicle development will shift substantial transportation energy demand from oil-supplied to grid-supplied, and will consequently put even further stress on the already over-stressed electrical grid. This vision requires the development of new battery chemistries and materials for stationary electrical energy storage applications with enhanced cycling, deep discharge capabilities, safety and low cost. This represents a major research challenge and opportunity. The key to battery-based stationary electrical energy solutions will be in new chemistries and new materials with enhanced properties for the stationary application including high energy density, deep cycling, long cycle life, safety and low cost. Specifi-

cally, our group will focus on synthesis, characterization and electrochemistry of low cost environmentally friendly anode materials. The elements to be used are naturally abundant, with lower cost and less environmental impact than many electrode materials in common use today. The overall objective of this work is development of novel anode materials for low cost large scale secondary batteries. Collaboration with Brookhaven National Laboratory will be leveraged to enable utilization of advanced synchrotron and electron tools to characterize the novel electrical energy storage materials. (NYSERDA)



Novel Materials Yielding High Energy, High Power, and Improved Reversibility

PIs: Esther S. Takeuchi, SBU and BNL,
Amy C. Marschilok and
Kenneth J. Takeuchi, SBU

This project will provide mechanistic insight and fundamentally advance the three key performance metrics for energy storage: energy density, power delivery and reversibility. These goals will be realized through development and study of a new class of energy storage materials. The project materials will provide opportunity for a multifold improvement in theoretical energy density over state of the art energy storage materials. A challenge to successful implementation of high-stability cathode materials for energy storage is overcoming their typically low electronic conductivity. The novel materials studied here will form in-situ conductive metallic networks, providing a materials design approach that will enable use of nanomaterials and enhance energy density. One metal ion of the material is reduced to the metallic state and will provide an in-situ conductive network, which will enable the use of small particles by minimizing the inter-particle contact resistance. This should provide high power to enhance the discharge and charge rates possible.

Additionally, this family of compounds will provide multiple electron transfers per formula unit to yield high energy content. Finally, these materials should facilitate the opportunity for enhanced electrochemical reversibility since the host superstructure will provide ion transfer channels that allow facile ion movement. (DOE)



Publications:
S. Zhu, A. Marschilok, C. Lee, E. Takeuchi, K. Takeuchi, *Synthesis and Electrochemistry of Silver Hollandite*. *Electrochemical and Solid State Letters*. 13(8), A98-A100 (2010).
C. Lee, A. Marschilok, A. Subramanian, K. Takeuchi, E. Takeuchi. *Synthesis and characterization of sodium vanadium oxide gels: The effects of water (n) and sodium (x) content on the electrochemistry of $\text{Na}_x\text{V}_2\text{O}_5 \cdot n\text{H}_2\text{O}$* . *Phys. Chem. Chem. Phys.*, 13, 18047–18054 (2011).
K. Farley, A. Marschilok, E. Takeuchi, K. Takeuchi. *Synthesis and electrochemistry of silver ferrite*. *Electrochemical and Solid State Letters*. 15, A23-A27 (2012).

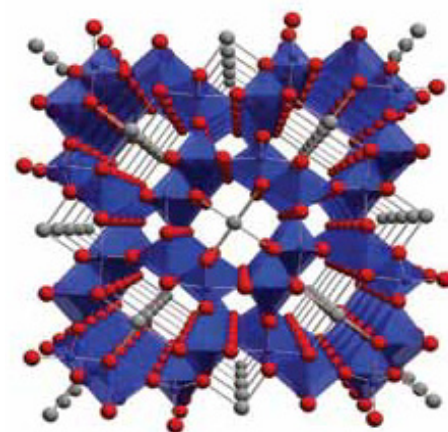

BATTERY AND STORAGE RESEARCH

Regenerable Battery Project

PIs: Esther S. Takeuchi, SBU and BNL, Amy C. Marschilok and Kenneth J. Takeuchi, SBU

Currently, effective recycling of advanced batteries is limited. Only lead acid batteries are effectively recycled. This results in large numbers of batteries moving to land fill. With increasing battery size, this becomes a significant issue. Globally, over 500 million electric vehicles are predicted to be sold by the year 2040, with US sales predicted to exceed 100 million. To achieve high quality power and effectively integrate renewable energy generation into the electric grid, large scale batteries will be required. If all large scale batteries used for these purposes are destined for land fills, the result could exceed hundreds of millions of metric tons of battery waste per year.

This program will reimagine battery design, manufacture, and use lifecycles to improve energy and reduce environmental impact. Novel concepts to extend the life of battery components and the possibility of reusing battery components will be explored and demonstrated. (Stony Brook Foundation.)

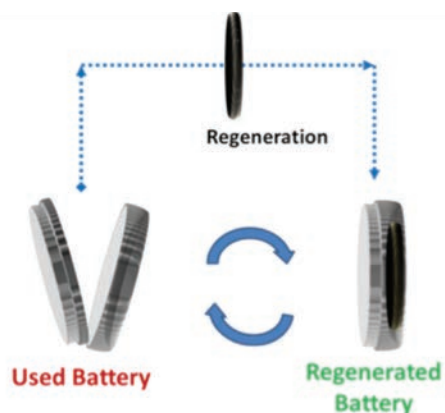

StorEn Vanadium Flow Battery

PI: Vyacheslav Solovyov, SBU

The vanadium flow battery (VFB) is a rechargeable flow battery that employs vanadium ions in different oxidation states to store chemical potential energy. The battery exploits the ability of vanadium to exist in solution in four different oxidation states and uses this property to make a battery that has just one electroactive element. The main advantages of the vanadium redox battery are that it can offer almost unlimited energy capacity simply by using larger electrolyte storage tanks, it can be left completely discharged for long periods with no adverse effects. The aqueous and inherently safe and non-flammable. All these features are very appealing for local energy storage. CIEES has installed the StorEn flow battery at our facility in Stony Brook, NY. The test plan includes evaluation of round-trip efficiency, total capacity, the maximum power etc. CIEES will work with Green Technology Accelerator Center at Rochester Institute of Technology to quantify environmental impact of implementing the battery technology at state level. (CIEES)



RESEARCHER PROFILE



Amy C. Marschilok, Research Professor, Department of Chemistry; Research Associate Professor, Department of Materials Science and Engineering; Center Operations Officer, m2m/t Energy Frontier Research Center

Awards and Honors:

- 2011 Woman of Distinction Award Education Category Recipient, Girl Scouts of Western NY
- 2007 Western New York YWCA Leadership Award Professional Service Category Recipient
- 2006 Greatbatch Visionary of the Year Award - Corporate Offices/Technology Center
- 2004 Mattern-Tyler Excellence in Teaching for Outstanding Teaching Assistant

Research Interests
Inorganic chemistry
Interfacial electrochemistry
Batteries, capacitors,
liquid and solid electrolytes



BATTERY AND STORAGE RESEARCH

Chemists Develop MRI-Like Technique to Detect What Ails Batteries

PI: Alexej Jerschow, NYU

It is surprisingly difficult to determine how long a battery will last, and what may be wrong with it. A series of high-profile failures and recalls have acutely highlighted this problem. Now, a team of NYU researchers have developed a technique that can nondestructively analyze cells either during manufacturing, or during use or testing, and determine certain defects and the state of charge. The method is fast, and provides an unprecedented look into cells. The underlying methodology is based on magnetic resonance imaging, and is used to measure the tiny changes in magnetic fields surrounding a cell when it changes charge state or becomes defective. The researchers anticipate that this technique could become a core tool in battery assessment and development and accelerate the introduction of higher capacity devices while insuring safety and reliability. (NSF, NYU Technology and Acceleration & Commercialization Program)

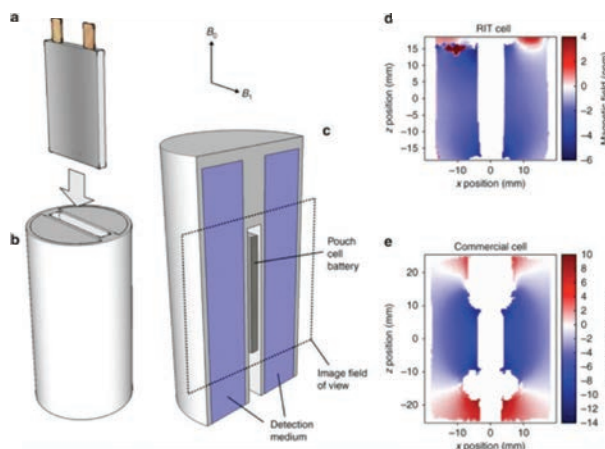

Magnetic field map measurements for the fully charged cells. a–c Sample placement, and image orientation; d, e field maps measured for the cells. Field maps are referenced here to the empty holder, giving an absolute field map for the Li-ion cell

Publication:
A. J. Iliott, M. Mohammadi, C. M. Schauerman, M. J. Ganter, A. Jerschow, *Nat Comm* 9:1776. <http://dx.doi.org/10.1038/s41467-018-04192-x>. (2018).



Multifunctional Cathode Additives for Li-S Battery Technology

PIs: Hong Gan, BNL and Esther Takeuchi, SBU

Li-S battery technology will be developed as a low-cost, high energy density alternative to current state of the art Li-ion battery technology. The Multifunctional Cathode Additives (MFCA) concept will address important challenges currently faced by the Li-S system by (1) improving cathode electronic conductivity, (2) providing excess lithium source, (3) reducing polysulfide dissolution in electrolyte. Successful development of Li-S battery incorporating the MFCA approach will enable low-cost, high energy density battery technology relevant for PEV application. (DOE)



System (ESS) and Renewable Energy Sources

PI: Vyacheslav Solovyov, SBU

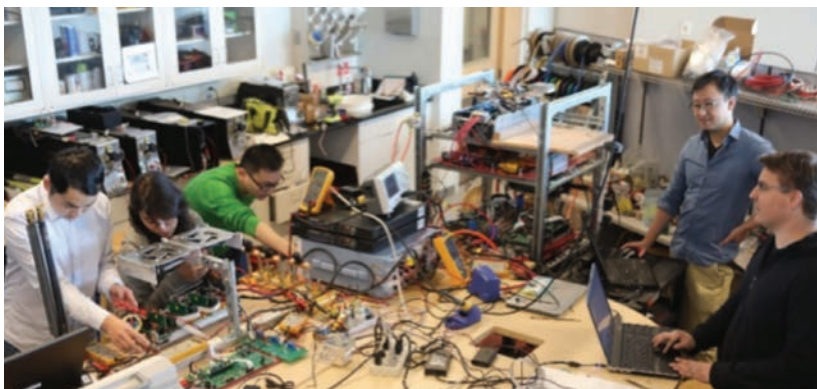

CIEES, in collaboration with Unique Technical Services (UTS), won a NYSERDA grant for evaluation of molten salt (ZEBRA) batteries. NYSERDA will grant 11 batteries (\$250K value) to evaluate applicability of the technology for seasonal energy storage in the Eastern Long Island corridor. The unique situation in Eastern Long Island is that the electricity demand is at a maximum in the summer due to a surge in the vacationer population. The CIEES-UTS team will install the battery pack and evaluate its performance as a seasonal storage solution for Eastern Long Island. (UTS)



SMART POWER MANAGEMENT

Design Methodologies for Low Power 3-D Integrated Circuits

PI: Emre Salman, SBU

Power consumption has become the fundamental barrier to further expanding the capabilities of modern integrated systems. Thus, energy efficiency has emerged as a critical challenge for many applications ranging from low power mobile/embedded chips to high performance data centers. Three-dimensional (3-D) integration has received considerable attention in the past decade to alleviate this issue. The primary objective of this research is to develop a reliable framework to facilitate highly heterogeneous and tightly coupled 3-D systems-on-chip (SoCs) for substantially complex applications where plug-and-play based approaches are not sufficient. This objective is achieved by simultaneously enhancing three interdependent design constraints of critical importance to this framework: power, signal and sensing integrity. The proposed circuit-level and physical-level design and analysis methodologies will serve as a novel framework to produce highly heterogeneous, low power yet robust 3D SoCs. (NSF)

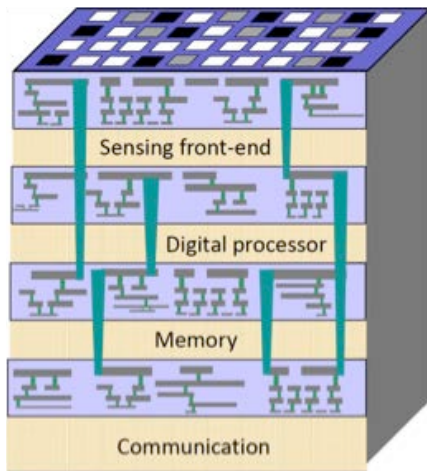

Wafer-level through silicon via (TSV) based 3-D integration to merge diverse electrical planes



The Effect of Web Optimizations on Mobile Power and Performance

PI: Aruna Balasubramanian, SBU

In this project, the project team will use critical path analysis, machine learning, and stochastic analysis to understand the performance and energy consumption of mobile browsers. The goal of this project is to analyze and predict the effect of a diverse set of network, Web, and browser optimizations on mobile page load times and energy consumption. The proposed

research will have significant impact given that mobile pages are the primary portals of content for over two billion mobile subscribers worldwide. The image below shows a power monitor that is measuring the power consumption of the phone, as a Web page is being loaded. (Google)



Enhanced Power System Operation and Control

PI: Eugene Feinberg, SBU

This project investigates and implements numerical algorithms and high performance computing software for solving power-flow, state-estimation and system-stability control problems for electric transmission grids. The main objective

is to develop solution methods that are 10 to 100 times faster than the solution times achieved in current control system implementations. (NYSERDA, NYPA)



SMART POWER MANAGEMENT

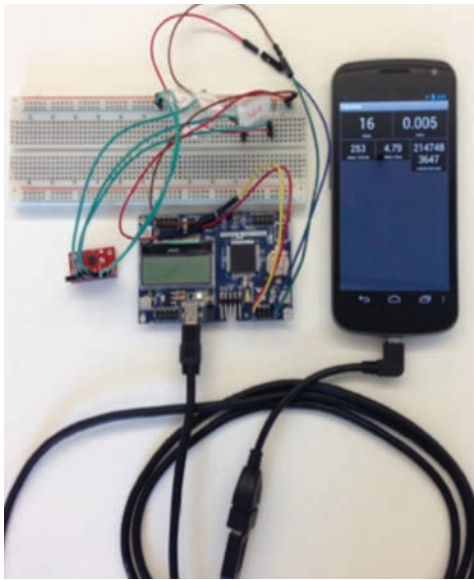

Enhancing Mobile Apps to Use Sensor Hubs Without Programmer Effort

PI: Aruna Balasubramanian, SBU

The goal of the NeTS project is to provide a power management solution for phones by identifying inefficiencies in different classes of applications. We redesign the mobile architecture based on these inefficiencies.

To this end, the MobileHub project works on significantly reducing the power consumption of sensing applications. Sensing applications abound the mobile application space, but they have to periodically wake up the mobile processor to collect and process the sensor data. Instead, MobileHub "offloads" sensing intelligently to a low power processor. The low power

processor, called a sensor hub, only draws a fraction of the power as the main CPU. We show that, even without application source code, we can automatically rewrite application binary so that an application can automatically leverage the sensor hub. Our experiments show that for sensing applications, MobileHub reduces power consumption by as much as 80%. (NSF)



Low Power Clocking Methodologies for Nanoscale CMOS Circuits

PI: Emre Salman, SBU

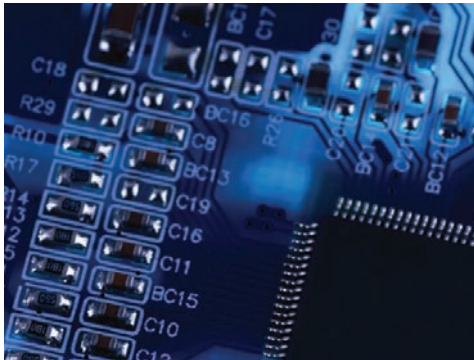

Existing methodologies to reduce power dissipation either trade performance or utilize the available (positive) timing slack. Sacrificing performance to achieve low power is feasible only for a small set of applications. Alternatively, exploiting the available slack to reduce power dissipation significantly increases the number of critical paths, making the circuit more susceptible to static and dynamic variations. This research aims to significantly reduce power consumption by focusing on the global and local clock distribution networks within a synchronous IC, while maintaining the same performance. The primary objective is to develop a novel low voltage clocking methodology that guarantees nearly same performance as full voltage operation, robust to both dynamic and static variations and can

be automated to produce the optimum operating conditions. Simultaneously satisfying these three conditions will enable us to reliably and automatically apply the proposed low voltage clocking technique to industrial synchronous circuits with an expected overall power reduction of up to 35%. (Semiconductor Research Corporation)



An Efficient, Versatile, Scalable, and Portable Storage System for Scientific Data Containers

PIs: Erez Zadok, Michael Bender and Robert Johnson, SBU

Scientific Bigdata sets are becoming too large and complex to fit in RAM, forcing scientific applications to perform a lot of slow disk and network I/O. This growth also makes scientific data more vulnerable to corruptions due to crashes and human errors. This project will use recent results from algorithms, database and storage research to improve the performance and reliability of standard scientific data formats. This will make scientific research cheaper, faster, more reliable and more reproducible. The Hierarchical Data Format (HDF5) standard is a container format for scientific data. It allows scientists to define and store complex data structures inside HDF5 files. Unfortunately, the current standard forces users to store all data objects and their meta-data properties inside one large physical file; this mix hinders meta-data-specific optimizations. The current storage also uses data-structures that scale poorly for large data. Lastly, the current model lacks snapshot support, important for recovery from errors. A new HDF5 release allows users to create more versatile storage plugins to control storage policies on each object and attribute. This project is developing support for snapshots in HDF5, designing new data structures and algorithms to scale HDF5 data access on modern storage devices to Bigdata. The project is designing several new HDF5 drivers: mapping objects to a Linux file system; storing objects in a database; and accessing data objects on remote Web servers. These improvements are evaluated using large-scale visualization applications with Bigdata, stemming from real-world scientific computations. (NSF)



Automatic Optimal Phase Balancing Algorithms for Electric Utilities

PIs: Thomas Robertazzi, and Steve Skiena, SBU

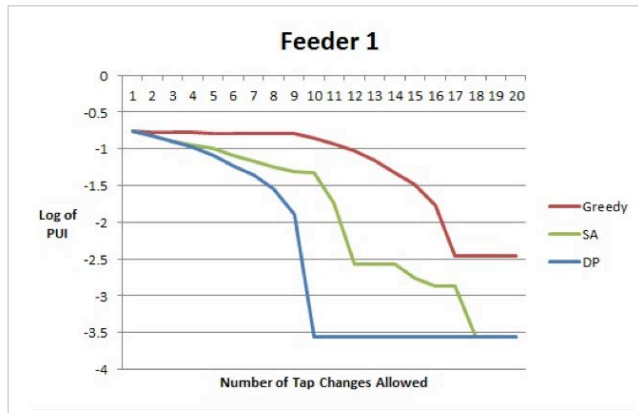

Figure 1: The phase unbalance index, which measures the amount of unbalance between phases, versus the number of tap changes for the dynamic programming, simulated annealing and greedy algorithms using actual feeder data. The more negative the log of the PUI, the better the phase balance.

The majority of electric power systems utilize feeders that carry three phases of alternating current/voltage. Electric utilities and providers of electric power distribution systems seek to have approximately equal loads on each phase, for several reasons:

1. Phase unbalance can limit the amount of power transferred on a feeder, as one phase may reach its maximum carrying capacity (measured in amperes, i.e. ampacity) while the other two phases remain underutilized and unable to carry their full, or even nearly their full, amount of current.
2. Poor utilization of the existing power distribution network may result in unnecessary feeder expansion and upgrades, which raises costs.
3. Phase unbalance can lead to severe voltage drops in the feeders and preventive breaker/relay tripping when one phase nears its maximum ampacity. The restoration of such feeders involves time and money.

Phase balancing aims to reduce the unbalance of loads by shifting them from overused to underutilized phases. The performance of an initially well-balanced network deteriorates with time, as loads increase, decrease and are added or removed from each phase. Phase balance changes substantially during the course of the day due to the substantial variation of load on each phase of a feeder.

We have developed novel dynamic programming algorithms to make recommendations to utilities on the best strategies for phase balancing. We have tested our algorithms on actual utility data under the LIPA/DOE Smart Grid project at Stony Brook. We have found significant cost savings thru the use of our algorithms. Extrapolated to the entire United States, the savings could be as high as 250 million dollars a year. This work is patent pending. (DOE)



SMART POWER MANAGEMENT

Adaptive Runtime Verification and Recovery for Mission-Critical Software

PIs: Scott Smolka, Scott Stoller and Erez Zadok, SBU

Runtime verification (RV) refers to the use of lightweight yet powerful formal techniques to monitor, analyze and guide the execution of programs at run-time. RV is becoming increasingly important for at least two reasons. First, software systems are becoming more complex and more adaptive, making it difficult to statically understand all of their possible behaviors. This is especially true of mission-critical software on autonomous, unmanned vehicles where completion of mission goals depends upon adaptive responses to changing conditions. Thus, RV plays a valuable role in helping users monitor and understand system behavior during testing, debugging and deployment. Second, to increase the reliability of complex adaptive software, RV must monitor and analyze the behavior of the software, its environment and their interaction, in order to trigger adaptive responses when necessary. To fill these needs, RV itself must become more flexible and adaptive and it must be equipped with a recovery framework that will help ensure mission completion in the face of runtime violations. We are developing Adaptive Runtime Verifica-

tion and Recovery (Arrive), a novel extension of runtime verification, in which the runtime verification itself is adaptive. Arrive dynamically allocates more runtime-verification resources to high-criticality monitored objects, thereby increasing the probability of detecting property violations within a given overhead budget. Moreover, when a violation is imminent, Arrive takes adaptive and possibly preemptive action in response, thereby ensuring recovery. We are investigating three related aspects of Arrive: overhead control, incomplete monitoring and predictive analysis. We are developing a Simplex architecture for cyber-physical systems by extending Simplex to monitor the software state, as well as the physical-plant state. We are evaluating the performance and utility of the Arrive framework through significant case studies, including the runtime monitoring of the command-and-control and energy-management infrastructure of a fleet of UAVs. (NASA JPL)



Quantitative Musings on the Feasibility of Smartphone Clouds

PIs: Radu Sion, SBU

In 2011, Google's data centers alone were consuming the equivalent electricity sufficient to power up 200,000 homes. Energy is a top 3 data center operating cost component. "Fully burdened power" (consumption+distribution) constitutes upwards of 30% of a large data center operating costs. This is why, at scale, ideas of deploying low-power ARM architectures or even large numbers of extremely "wimpy nodes" seem increasingly appealing. Skeptics, on the other hand, maintain that we cannot get more than what we pay for and no free lunches can be had. In this white paper, we explore these theses and provide insights into the power-performance tradeoff at scale for ARM architectures. We quantify the cost/performance ratio precisely enough to allow for a broader conclusion. We then offer an intuition as to why this may still hold in 2030. (NSF)



TTP: Small: NFS4Sec: An Extensible Security Layer for Network Storage

PIs: Erez Zadok and Radu Sion, SBU

The Network File System (NFS) is a popular method for computers to access files across networks. The latest major version of this IETF protocol, version 4, is widely accepted and includes numerous new features to improve security, performance and usability when used over wide-area networks. However, the NFSv4's security focus is on network-wide encryption (ensuring that user data cannot be intercepted) and user authentication (ensuring that only legitimate users can access their files). It does not address end-to-end data security (i.e., persistently stored data), data integrity (malicious or benign data corruptions) and more. This project extends NFSv4 with a security layer that allows one to develop multiple, composable

plugin modules to enhance the protocol's security. This layer allows for interception of protocol requests between clients and servers to perform various useful security functions such as:

- logging access to files by users and hosts, useful for regulatory compliance reports and audits
- inspecting files for malware patterns and automatically quarantining them
- verifying the integrity of long-lived files against malicious changes (e.g., Trojan intrusions) and benign but serious ones (e.g., storage media degradation and hardware corruptions)

- detecting denial-of-service attempts and ensuring quality-of-service to legitimate users through load-balancing and redirection; automatic snapshotting and logging to allow for forensic analysis and recovery from failures and intrusions.
- In a cloud-based era, where more data lives longer and is accessed over wide-area insecure networks, this project helps elevate the level of security of every user's data files. (NSF)



SMART POWER MANAGEMENT

MCloud: Secure Provenance for Mobile Cloud Users

PIs: Radu Sion, SBU and Bogdan Carbutar, FIU

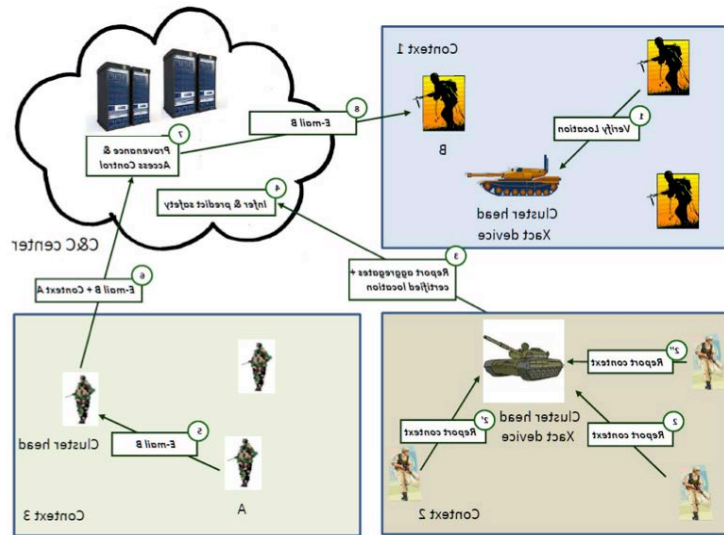

bility, as well as outsourcing their computation and data storage to cloud providers. For example, suppose the commander of a deployed team needs to prepare a report based on information received from his teammates. Since the information aggregated in the report comes from different sources, an adversary needs to capture a single team member's device to inject

but accidentally include an unauthorized recipient.

The goal of this proposal is to address two critical challenges. The first challenge is to track data, its contexts and its changes, as it flows across multiple mobile and back-end systems and principals for security and regulatory compliance (e.g., ensuring documents derived from classified data stay classified, or tracking the history of intelligence and other data used for decision-making). The second challenge is to enforce security policies uniformly across a large set of principals, compute environments and applications. (ARMY)



Defense, intelligence and other government agencies are increasingly sharing diverse applications, data and hardware platforms of varying degrees of mo-

incorrect information and corrupt the report. Furthermore, the commander may copy excerpts of the report into an email intended for approved team members

Thermoelectrically Driven Sensing for Nuclear Power Plants

PIs: Jon Longtin, David Hwang, SBU, Lei Zuo, Virginia Tech, Minking Chyu, U.Pitt

Catastrophic events such as that at Fukushima have raised new awareness for robust, reliable sensing and data feedback during catastrophic events. This project is developing thermoelectrically driven wireless sensing packages for nuclear power plants. In the event of a major incident in which all other forms of power to the plant are unavailable, intrinsic heat from the reactor components is used to produce electricity using thermoelectric generators. This energy is stored and then used to drive a sensor network to monitor key parameters such as temperature, pressure, radiation, flow rates, water levels, etc. The project involves the thermal design of the system, the sensor and electronics packaging, the wireless interfacing, power management and developing designing protection for the sensor package once

attached to the component. Excess electrical energy can be stored by a battery and used for actuation as well. For example to open or close a valve, pressure vessel vent, drain, or other critical component that requires power to maximize plant safety. Innovative thermal technologies such as heat pipes and high-performance heatsinks are used to maximize electricity production. The Calpine power plant on campus has generously allowed us to install a prototype design on the main steam line to campus in October 2014, which has been operating successfully since installation. (DOE NEUP)



SMART POWER MANAGEMENT

Evaluation of the Bureau of Energy Resources (ENR) Unconventional Gas Technical Engagement Program (UGTEP)

PI: Devinder Mahajan, SBU

The Department of State's Bureau of Energy Resources (ENR) works across the U.S. Government to engage traditional energy exporters and emerging economies in a coordinated effort to boost international energy security and provide advice to steer the world's energy mix toward a more sustainable path. ENR is engaged with other countries through the Unconventional Gas Technical Engagement Program (UGTEP). The purpose of this evaluation is to review the current performance and effectiveness of the Unconventional Gas Technical Engagement Program (UGTEP) and make recommendations that will increase the effectiveness of future programming. (DOS)



Evaluation of Additive Manufactured Composites for Energy Applications

PI: Vyacheslav Solovyov, SBU

ChemCubed is a fast-growing company in the advanced composites field. CIEES will evaluate performance of composites manufactured by a variety of additive technologies, such as 3D printing. During the project, CIEES will perform mechanical and structural tests of composited samples provided by ChemCubed. The project will help ChemCubed expand their manufacturing capacity. (ChemCubed)



EcoHadoop: A Cost-Efficient Data and Task Co-Scheduler for MapReduce

PI: Radu Sion, SBU

We introduce a new energy cost-efficient data and task co-scheduler for MapReduce in a cloud environment. By using linear programming to simultaneously co-schedule data and tasks, LiPS helps to achieve minimized dollar cost globally. We evaluated LiPS both analytically and on Amazon EC2 with significant results. LiPS saved up to 81% of the actual dollar costs when compared with both the Hadoop default and the more performant delay scheduler, while also allowing users to fine-tune the cost-performance tradeoff. LiPS presents today's most cost-efficient scheduler and should be deployed when constraints on overall makespan are flexible. (NSF)



DIMMer: A Case for Turning Off DIMMs in Clouds

PIs: Radu Sion, Michael Ferdman, SBU

Lack of energy proportionality in server systems results in significant waste of energy when operating at low utilization, a common scenario in today's data centers. We propose DIMMer, an approach to eliminate the idle power consumption of unused system components, motivated by two key observations. First, even in their lowest-power states, the power consumption of server components remains significant. Second, unused components can be powered off entirely without sacrificing server availability. We demonstrate that unused memory capacity can be powered off, eliminating the energy waste of self-refresh for unallocated memory, while still allowing for all capacity to be available on a moment's notice. Similarly, only one CPU socket must remain powered on, allowing unused CPUs and attached memory to be powered off entirely. The DIMMer vision can improve energy proportionality and achieve energy savings. Using a Google cluster trace, as well as in-house experiments, we estimate up to 50% savings on DRAM and 18.8% on CPU background energy. (NSF)



Smart Meter Security Testing

PI: Rob Johnson, SBU

We will perform security evaluations of smart grid devices. Evaluations will include (1) black box testing, i.e. feeding random or malformed inputs to the devices and observing whether they handle the inputs correctly, crash, or otherwise misbehave; and (2) manual evaluation, i.e. testing functionality on correct inputs and verifying that no dangerous functions, such as debugging interfaces, are present in production versions of the devices. (DOE)



SMART POWER MANAGEMENT

Condensing Flue Gas for Sub-Ambient Evaporative Cooling and Cool Storage

PI: Jon Longtin, SBU

Power plants that do not require a large body of water for cooling, and/or that consume little to no water for operation would significantly enhance U.S. electricity production potential. Evaporating water is an extremely effective cooling mechanism, but the water is lost during the evaporation process. The power plant itself, however, produces significant quantities of water vapor through the natural combustion process. The objective of this project is to condense water vapor from the combustion byproducts (flue gas) by using a high-performance thermosyphon to move heat from the flue gas to the ambient with no additional refrigeration system required. A thermosyphon uses the latent heat of vaporization — rather than a temperature gradient — for heat transfer. As such, the thermal resistance

for heat transfer can be substantially reduced. The condensate will be stored and used for subsequent evaporative cooling using commercially available technologies. The project presents several innovations in terms of active fluid management and co-current flows in the thermosyphon, polymer-based components in the flue gas to minimize corrosion effects, and a simulation-driven, highly optimized design. The technology is suited for coal, natural gas, or combined-cycle plants. This technology meets the ARPA-E Program Objectives of dissipating no net water to the atmosphere, no loss of efficiency for the power plant, and being implemented with less than a 5% increase in the levelized cost of electricity. The project addresses the ARPA-E Mission Area of

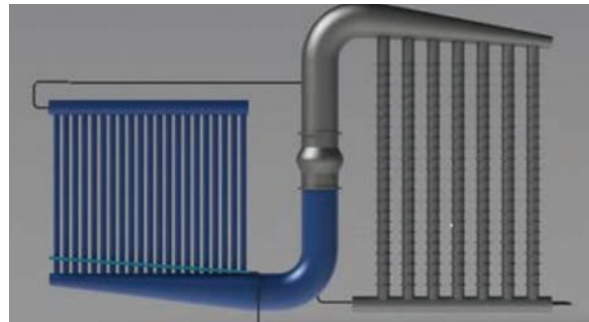

ensuring that the United States maintains a technological lead in developing and deploying advanced energy technologies. (ARPA-E)



Fundamental Research of 2D Zeolite

PI: Tae Jin Kim, SBU

Argon and other noble gases have previously been trapped in three-dimensional (3D) porous materials, but immobilizing them on surfaces had only been achieved by either cooling the gases to very low temperatures to condense them, or by accelerating gas ions to implant them directly into materials. Recently, the SBU and BNL research team has synthesized a two-dimensional (2D) structure and successfully trapped argon atoms inside the nanosized pore structure at room temperature. This achievement, reported in a paper published in *Nature Communications*, will enable scientists to use traditional surface-science tools—such as x-ray photoelectron and infrared reflection absorption spectroscopy—to perform detailed studies of single gas atoms in confinement. The knowledge gained from such research could inform the design, selection, and improvement of adsorbent materials and membranes for capturing gases such as radioactive krypton and xenon generated by nuclear power plants. This research is carried out in part at Cen-

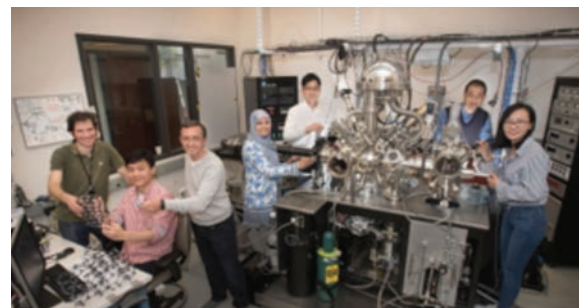
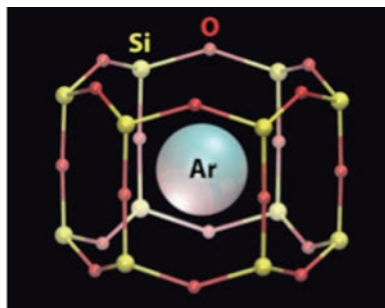

ter for Functional Nanomaterials and the CSX-2 beamline of the National Synchrotron Light Source II, Brookhaven National Laboratory, which is supported by the U.S. Department of Energy, Office of Basic Energy Sciences, under Contract No. DE-SC0012704. This research used resources of the National Energy Research Scientific Computing Center, a DOE Office of Science User Facility supported by the Office of Science of the U.S. Department of Energy and was supported by Brookhaven's Laboratory Directed Research and

Development program and the National Scientific and Technical Research Council (CONICET) of Argentina. (DOE)



Publication:
J.Q. Zhong, M. Wang, N. Akter, J.D. Kestell, A.M. Boscoboinik, T. Kim, D.J. Stacchiola, D. Lu, J.A. Boscoboinik, *Immobilization of single argon atoms in nano-cages of two-dimensional zeolite model systems*. *Nat. Commun.* (2017).

SMART GRID AND MICROGRID

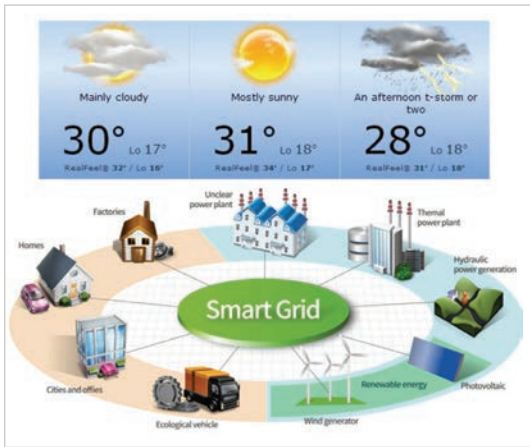

Secure, Reliable and Integrated Smart Grid Solutions Under Variable Weather Conditions

PIs: Eugene Feinberg, SBU
Alexander Domijan, UB, and
Ilya Grinberg, Buffalo State College

The project focuses on the integrated analysis and improvements of smart grid reliability with dynamic reconfiguration under variable weather conditions. This project develops and implements algorithms and software solutions for distribution network reconfiguration under variable weather conditions and demonstrates the developed solutions in the lab at the physical level. (Research Foundation of SUNY, 4E Network of Excellence Program)

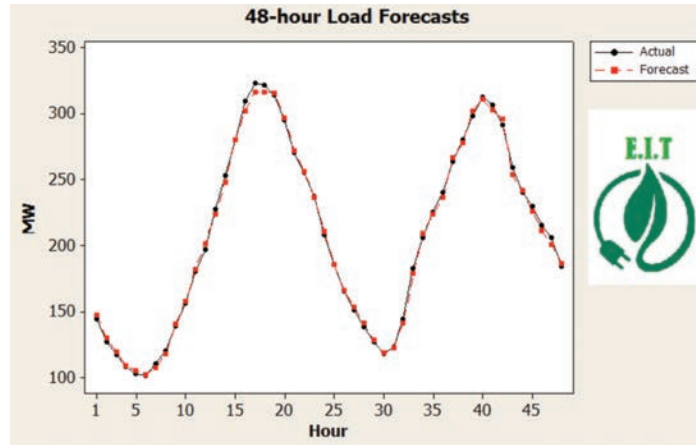

Smart Grid Integration of Energy and Information Technologies for Energy IT, Inc.

PI: Eugene Feinberg, SBU

This project involves three major tasks:

1. Providing guidance to upgrade the current products to make them meet the Smart Grid standards, including both the hardware and software standards.
2. Develop short-term load forecasting models using time-series analysis and/or methods of artificial neural networks.
3. Develop fault detection and location models for distribution network using statistical learning.

(Energy IT, Inc., and Sensor CAT)

Sensor CAT
CENTER FOR ADVANCED TECHNOLOGY
IN SENSOR SYSTEMS
AT STONY BROOK UNIVERSITY

RESEARCHER PROFILE



Eugene A. Feinberg, Distinguished Professor,
Department of Applied Mathematics and Statistics.

Awards and Honors:

- Fellow of INFORMS (2011)
- SUNY Distinguished Professor (2012)
- IEEE Charles Hirsh Award (2012) for developing and implementing on Long Island, electric load forecasting methods and smart grid technologies
- Honorary Doctor, Institute of Applied System Analysis, National Technical University of Ukraine (2011)
- SBU Director of DOE Smart Grid Regional Demonstration Project: Long Island, Smart Energy Corridor (2010 – 2015)

*Energy Projects
Smart Grid
Electric Load Modeling
and Forecasting
Modeling and Optimization
of Electric Power Trans-
mission and Distribution*

SMART GRID AND MICROGRID

Analytics Framework for Understanding Household Energy Consumption

PI: Klaus Mueller, SBU

The introduction and gradual popularity of energy consumption monitoring devices, commonly known as smart-meters, has provided us with an opportunity of capturing and understanding household energy. Our interface provides various visualizations in which users can interactively explore their energy use profiles. They can select and compare different time segments of their profiles and show them in context of

local weather (obtained from a weather service), social activities (obtained from a calendar) and the use of their household devices (obtained from the user via a visual user interface). Our visual interface aggregates all this information into a modern multi-faceted information visualization framework that can be interactively manipulated to allow users to learn where, when and how energy was consumed. Once the sources of adverse energy consumption have been identified, users can employ the historical data to play out



different use behaviors and see the effect on energy use, as well as the size of the energy bill. They can also use the software to predict future or replay past energy consumptions with changed habits, devices and their settings. The insight gained can then lead to positive energy-use behavioral changes by the consumer, which is of benefit to everyone involved. (NSF)



Dynamic Islanding as an Accelerant for Grid Restoration and Enhancement to Reliability

PIs: Guodong Sun, SBU and Hyungseon Oh, UB

Dynamic islanding, the creation of ad hoc microgrids, is an innovative approach to mitigate the impacts of grid outages on customer power supply through the utilization and dispatch of distributed energy resources (DERs), including both generation and storage. There is growing interest in dynamic islanding after recent hurricanes and winter storms. Funded by a seed grant from SUNY 4E Network, New York Energy Policy Institute is organizing a workshop to convene leading experts from SUNY schools and beyond to engage in in-depth discussions on dynamic islanding. This workshop will discuss the topics including their roles, potentials and technological/economic/policy challenges in implementing dynamic microgrid and policy changes required to test, demonstrate and eventually deploy this approach. (SUNY RF)



Smarter Electric Grid Research, Innovation, Development, Demonstration, Deployment Center (SGRID3)

PIs: Robert Johnson and Erez Zadok, SBU

Smart Grids collect vital data about system operation, energy production and use, information flow, user activity and much more. This data must be secured and preserved for decades. In this project, we will investigate techniques to store this data securely using, for example, strong encryption while re-encrypting periodically to keep up with technology trends. We will include policies for data access such that only authorized users can access the data they require. In addition, we will include immutable methods to record and log all accesses (e.g., provenance) such that it would be possible to determine which user(s) accessed which data and when (this is useful for forensics and mitigating the "insider problem"). All data and logs will be replicated securely across several geographically distributed locations (we propose to use CEWIT in New York and CEWIT-Korea as two sample

sites). Further, we will develop techniques to resist Denial-of-Service (DoS) attacks by detecting sudden spikes in unexpected activity, logging them, throttling them and possibly blocking such connections. Our development platform will utilize the Network File System (NFS) version 4.1 protocol, a data storage protocol suitable for wide-area (e.g., cloud storage), secure, replicated data access. (BNL)



Smart Grid National Energy Control Center

PIs: Arie Kaufman and Klaus Mueller, SBU

We will develop new visualization and interaction paradigms, using the RealityDeck, for the SCADA system of the future. The RealityDeck is an immersive Giga-pixel display wrapping around a room of size 40' x 30' x 11' high, containing 416 LCD display screens driven by an 70 graphics processing unit (GPU) cluster that rivals the performance of modern supercomputers. The RealityDeck will fully immerse visitors in 1.5 billion pixels of information, approaching the visual acuity of the human eye. It will allow national energy grid analysts to manage the smart grid's large, multi-variate data, maintain a comprehensive view of the nation's complex energy infrastructure, quickly react to emerging prices or problems and take preventive measures before they arise. (NSF, NGC).



SMART GRID AND MICROGRID

Smart Grid Android Manager

PI: Radu Sion, SBU

The Mobile Smart Energy Manager is an Android/iPhone based Energy Manager that runs on smart phones and tablets. It will connect to local autonomous micro-grid information gateways and components (such as solar panel relays), the macrogrid operators and utility companies' portals, smart home components and the internet to provide real-time energy-related information, debit and consumption data, billing and the ability to manage smart-home devices in real-time on-demand. The Mobile Smart Energy Manager will also allow a unified user control platform for the integration of various external smart grid data processing and visualization plugins. Examples of such plugins include: 1) big data analytics visualization of micro-grid and macro-grid energy data, 2) connectivity conduit to external data sources and 3) visual devices,



such as the reality deck display and the SCADA smart grid control center, 4) networking plugins to interface with any additional custom wireless protocols designed as part of the SGRID3 project. (DOE)



Transportable Energy Storage for Enhancing Power Grid Resiliency to Natural Disasters

PIs: Yury Dvorkin and Miguel Modestino, NYU

This project is motivated by the society-scale urgency of reducing the impact of natural disasters on power grids in the light of increasing frequency and damage of hurricane strikes in the US Atlantic and Gulf Coast region. One way to enhance the ability of power grid operators to withstand such disasters is to ensure availability of backup flexibility resources that can be timely deployed prior to the disaster. This flexibility can then be used to prevent critical equipment failures during the disaster and to accelerate post-disaster grid restoration.

This project will develop and validate the concept of mobile energy storage (ES) units that can provide backup flexibility to power grids. Provided a timely disaster scenario, these units can be moved using public transportation routes from their stationary locations to the locations, where they can enhance power grid resiliency. This objective requires addressing two immediate research gaps. First, there is no decision-making strategy that can optimally route, reconfigure and control

mobile ES units as needed to reduce the impact of the anticipated disaster. Second, existing ES technologies makes it difficult to reconfigure ES units on a short notice. Using the real-life predictions and ex-post data from Hurricane Harvey, this project will design a data-driven approach to enable the optimal routing, reconfigure and control of mobile ES units to enhance power grid resiliency. The proposed approach will be accompanied by the development of a new electrochemical ES mechanism that is capable of generating two transportable energy carriers: redox-active species (such as those used on redox flow batteries) and hydrogen (e.g. available in refineries along the US Gulf Coast). Methodologically, this project will advance techniques for solving multi-stage optimization problems with binary recourse decisions and grid-scale energy storage mechanisms based on electrochemical water splitting reactions with solution-based redox couples as intermediates for water electrolysis. (NSF)



Electrical Grid Monitor System (EGMS) Based on Modern Sensor, Communication and Computational Technologies

PIs: Satya Sharma, Serge Luryi, Michael Gouzman, and Peter Shkolnikov SBU

A network of sensors is associated with a power distribution network. Sensors are positioned at each connecting line in the vicinity of each node of the power distribution network. The sensors regularly report the following measured data to the central processing unit: a geographical position of each sensor, direction of the energy flow relative to the nearest node; and value of RMS current synchronously measured over the entire network and averaged over chosen averaging period. The central processing unit includes an arrangement for receiving the measured data and using this data for constructing and updating a graph and a state of the power distribution network. Based on the proprietary technology (provisional patent), three main components are to be developed:

1. Inexpensive, robust, and non-intrusive sensors for current and voltage
2. The communication network
3. The information processing and visualization system (SBU)



SMART GRID AND MICROGRID

Controlling Non-Synchronous Microgrids for Load Balancing of Radial Distribution Systems

PIs: Tianqi Hong and Francisco de León, NYU

This project proposes a novel control strategy such that downstream non-synchronous microgrids can perform load balancing functions. The proposed method can eliminate (or reduce) the unbalance of currents at the substation transformer of radial distribution systems. The load balancing ability of microgrids has been studied for two different scenarios: using communications between the microgrid and the substation; and, using only local measurements at the microgrid. The limitations posed by the availability of measurements and system topology requirements for the success of the process are discussed. Two numerical examples are provided to validate the proposed control scheme with time domain and time-sequence power-flow simulations. (NYU)



TANDON
SCHOOL OF
ENGINEERING

Publication:
T. Hong, F. de León, *Controlling Non-Synchronous Microgrids for Load Balancing of Radial Distribution Systems*, IEEE Transactions on Smart Grid, Vol. 8, No. 6, November pp.2608-2616 (2017).

Centralized Unbalanced Dispatch of Smart Distribution dc Microgrid Systems

PIs: Tianqi Hong and Francisco de León, NYU

This project is about three proposed operation strategies such that a set of dc microgrids in distribution systems can co-operate pursuing particular objectives: loss reduction, full unbalance compensation, and partial unbalance compensation. Loss reduction is a regular strategy for distribution utilities operating their systems efficiently by optimal dispatch of three-phase in/out powers of dc microgrids. Full and partial unbalance compensation strategies can solve single- or two-phase overloading problems of substation transformers temporarily and slow down their aging process. To validate the performance of the proposed operation strategies, several steady-state studies are performed in the IEEE 123-bus test system. According to the simulation results, the operation losses can be reduced by up to 34% with 15.2% DG penetration. The maximum single-phase loading of the substation transformer can be reduced by up to 30%. (NYU)



TANDON
SCHOOL OF
ENGINEERING

Publication:
T. Hong, F. de León, *Centralized Unbalanced Dispatch of Smart Distribution dc Microgrid Systems*, accepted for publication in the IEEE Transactions on Smart Grid.

Smart Load Management of Distribution-Class Toroidal Transformers Using a Dynamic Thermal Model

PIs: Haowei Lu, Akim Borbuev, Saeed Jazebi, Tianqi Hong and Francisco de León, NYU

Thermal behavior is a prime factor in the accurate performance assessment of power transformers as well as in the prediction of their life expectancy. This project develops a computer modelling tool based on an electro-thermal equivalent circuit of transformers that is able to predict the hot spot temperature and average surface temperatures for all internal layers of distribution-class toroidal transformers. Temperature is the limiting factor that prevents running transformers for hours or days in overload conditions. The modelling tool presented is capable to identify the safe maximum overload current and duration that a transformer can handle without introducing damage or loss of life. The model is helpful to predict the short-term (few hours) and long-term (few days) overload capabilities of transformers. The electro-thermal model can also be used as a tool to optimize the design and evaluate the performance of transformers. The model is built using circuit components (lumped R and C) obtained from the thermal-electrical analogy. The model is validated with numerous Finite Element Method (FEM) simulations and laboratory tests with transformers of various power ratings. (NYU)



TANDON
SCHOOL OF
ENGINEERING

Publication:
H. Lu, A. Borbuev, S. Jazebi, T. Hong, F. de León, *Smart Load Management of Distribution-Class Toroidal Transformers using a Dynamic Thermal Model*, IET Generation, Transmission & Distribution, vol. 12, no. 1, January, pp. 142-149 (2018).

RESEARCHER PROFILE



Qing Zhang, Assistant Professor
Department of Mechanical Engineering

Awards and Honors:

- National Science Foundation Fellowship CAREER Award (2014)
- General Motors Boss Kettering Awards (2008, 2006, 2005)
- General Motors R&D Center The Charles L. McCuen Special Achievement Awards (2008, 2006 and 2005)

Energy Projects:

Battery Manufacturing System Efficiency Improvement
Manufacturing System Energy Management
Integrated Micro-grid and Production System

SMART GRID AND MICROGRID

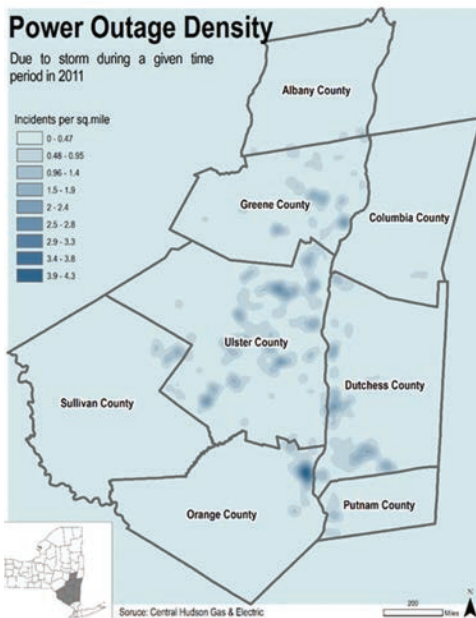

Impacts of Severe Weather Events on the Carrying Capacity of Distribution Grid

PI: Guodong Sun, Sung Gheel Jang, SBU and Martin Schoonen, BNL

The devastation caused by severe weather events (e.g., Hurricanes Sandy and Irene) raised awareness of the potential of climate change to exacerbate weather hazards such as hurricanes, Nor'easters, severe winter weather and flash floods. The storms caused substantial damage to the energy infrastructure. This project examines the performance of the electric distribution system and areas of vulnerability revealed by Hurricane Sandy, including interactions between electric power and water bodies (flooding and surge). The project will identify system improvements to increase resiliency, which may include reinforcing substations against flooding, microgrids, combined heat and power, distributed generation, smart grid technologies and energy storage. (HUD)



An Interactive User Interface for the Smart Grid

PI: Arie Kaufman and Klaus Mueller, SBU

In the traditional system, customers just purchase the energy from suppliers and consume it. However, smart grid is two-way communication channel between suppliers and consumers. The roles of consumers are to reduce their total consumption and shift their usage to off-peak time. However, it is difficult to encourage consumers to change their behavior with simple visualization. In this project, we have developed an interactive system to help customers gain better understating of their energy consumption. In our system, since customers hardly understand their energy consumption of their own electric devices, customers could configure their own virtual house with electric devices to estimate their current energy consumption. Customers could choose what kind of devices they have by dragging and dropping an electric device into their virtual house. Customers can easily select a specific model of each device. Our system also provides a tool to analyze their energy consumption pattern in order to control their energy usage efficiently. Given their total energy consumption from their smart meters, it shows their daily, weekly and monthly energy usage patterns. In addition, it enables customers to predict their energy consumption once they replace their current electric devices with new ones. (DOE)



Resilience Benefits of Distributed Energy Resources

PI: Guodong Sun, SBU

Severe weather events can cause large-scale power outage for extended periods. Enabled by dynamic islanding technology, distributed energy resources (DERs), including combined heat and power (CHP) and plug-in hybrid electric vehicle (PHEV), have large potential for accelerating the restoration process and for mitigating the impacts on critical facilities (hospitals, fire stations, police stations, telecommunication facilities, et al), households and businesses that are beyond the designated service territories of CHPs and PHEV-owners' houses. The objective of this study is to understand the resilience benefits of DER-powered dynamic microgrid. This study starts with an assessment of the arbitrage value of PHEVs to owners. It is followed with a study on the cost of electricity from CHP and PHEVs, as emergency generators, in a microgrid formed through dynamic islanding. (SBU)



RESEARCHER PROFILE



Erez Zadok, Professor and Graduate Academic Adviser, Computer Science Department, College of Engineering and Applied Science, Stony Brook University

Awards and Honors:

- * Dell-EMC Faculty awards, 2014-2018
- NetApp Faculty awards in 2009 and 2011
- LISTnet's "Top 20 techies of Long Island award, 2009
- Chancellor's Award for Excellence in Teaching, State University of New York (SUNY), 2007-2008
- IBM Faculty Awards: 2006 and 2008
- NSF CAREER award, 2002

Energy Projects:
Computer System Auto-Tuning
Trace Analytics
Smart Grid Security
Data Deduplication

EDUCATION AND OUTREACH

THE ADDITIVE MANUFACTURING MATERIALS, PROTOTYPING AND APPLICATIONS CENTER (AMMPAC)

The **Additive Manufacturing Materials, Prototyping and Applications Center (AMMPAC)** leverages leading expertise and state-of-the-art analytical and manufacturing equipment at Stony Brook University (SBU) and at the Composites Prototyping Center (CPC) to support education, training, adoption and optimization of additive manufacturing technologies. This is accomplished via a collaborative model for access to:

- Prototyping facilities at SBU and CPC, including fused deposition thermoplastic polymer and composite printing, UV photopolymerization and Digital Light Processing (DLP) printing;
- Advanced functional materials research and development facilities, including polymer nanocomposite blending and extrusion equipment, systems for spark plasma sintering and ball milling, wet chemistry and electrochemical synthesis;
- State-of-the-art testing and characterization at SBU (including surface X-ray and chemical (vibrational) microspectroscopies, X-ray fluorescence, scanning electron microscopy, mechanical impact, tensile strength and adhesion testing, and facilities for accelerated degradation tests), at CPC (mechanical testing and digital scanning), and via university collaborations with nearby Brookhaven National Laboratory (providing synchrotron-based X-ray imaging and spectroscopy as well as nanoscale imaging, X-ray diffraction and tomography); and
- Advanced digital design assistance (at SBU, including collaboration with the new Digital Design Laboratory in the Dental School and computational mechanics and multiscale design expertise in the Department of Mechanical Engineering).

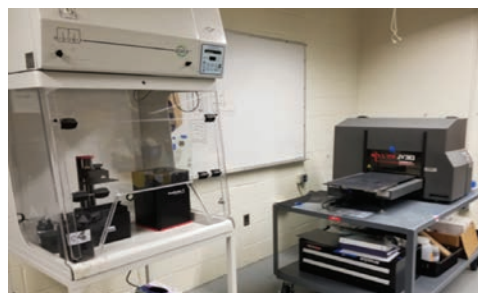

Other local partners are being engaged to broaden the impact of AMMPAC activities, including the New York State Advanced Energy Center (which houses an industrial partner focused on design of materials for additive manufacturing as well as other potential end-users), the facilities under development for the engineering-driven medicine initiative for the College of Engineering and Applied Sciences at Stony Brook (which will include a research focus in organ printing), the outreach programs of the Institute for Research and Technology Transfer at Farmingdale State University, Suffolk County Community College's Manufacturing Technology facility, and new collaborative activities between AMMPAC and the New York Institute of Technology and Columbia University. Additional collaborations will help to grow the center into new markets and opportunities, regionally as well as nationally. AMMPAC also has representation in the SUNY Networks of Excellence and NYSERDA additive manufacturing initiatives, promoting further growth and outreach.

www.stonybrook.edu/commcms/ampac/

CONTACT

Dr. Gary Halada

Department of Materials Science and Engineering, Stony Brook University
gary.halada@stonybrook.edu

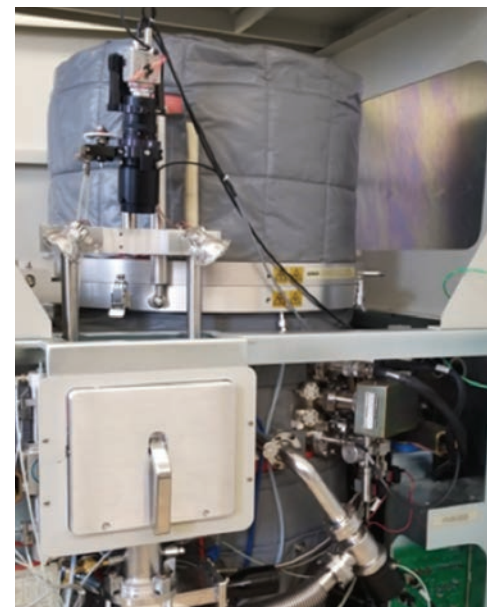

EDUCATION AND OUTREACH

THE LONG ISLAND ALTERNATIVE ENERGY CONSORTIUM

The **Long Island Alternative Energy Consortium** is a cooperative effort by seven public and private colleges and universities (Stony Brook University, Farmingdale State College, SUNY Old Westbury, SUNY Maritime, New York Institute of Technology, Suffolk County Community College and Nassau Community College), working with public entities (including Brookhaven National Laboratory) and private companies, to ensure that students get the education and training they need to work in the emerging and rapidly evolving industries of renewable and alternative energies, including photovoltaics, advanced materials for energy storage, and offshore wind energy.

This collaboration is the beginning of a broad interdisciplinary focus on energy and related issues for a variety of career paths. The ultimate goal is to boost the Long Island economy and contribute infrastructure jobs in the energy sector. Academic Program Development – faculty at these colleges will work closely with each other and with industry and government representatives to enhance existing or develop new, academic programs for students interested in working in businesses that design, industrialize, distribute or assess alternative energy for the benefit of Long Island, New York State and the nation as a whole. For example, a new minor in energy science, technology and policy (ESTeP) - enriched with content from multiple campuses - was developed with NSF support to provide students with the skills to analyze energy policy decisions, follow the dynamics of various energy markets and understand how to use and manage emergent energy technologies. Students from underrepresented populations and nontraditional students, such as veterans or those seeking new careers, are among the demographics the minor targets.

Lectures and Conferences – in order to facilitate the discovery and understanding of key issues in the field, members of the Consortium sponsor lectures and conferences relating to sustainable and alternate

energy, bringing in experts to interact with students, faculty, government agencies and private companies. The institutions also work with many organizations such as the Department of Labor, the Workforce Development Institute, and BOCES to host job fairs where Long Island businesses can find well-prepared students to work in Long Island's emerging energy sector through job fairs.

Internships – companies, government agencies, colleges and universities (via their placement offices and faculty/internship referrals) will collaborate to enable students to acquire meaningful, job-related work experiences on Long Island, earn academic credit and develop skills, insight and experience that will guide their future careers.

Collaborative Research – the Consortium will link Long Island's world class college and university resources in basic and applied research to business and government communities in order to bring innovative solutions to their impending energy problems.

liaec.aertc.org

CONTACT

Dr. Gary Halada

Department of Materials Science
and Engineering, Stony Brook University
gary.halada@stonybrook.edu

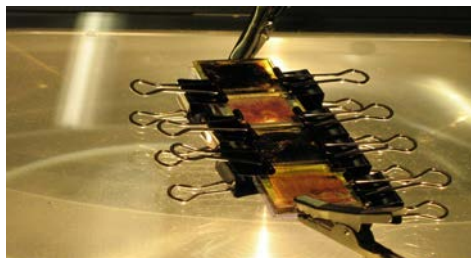

Undergraduate class project on nanocrystalline dye solar cells at SBU.

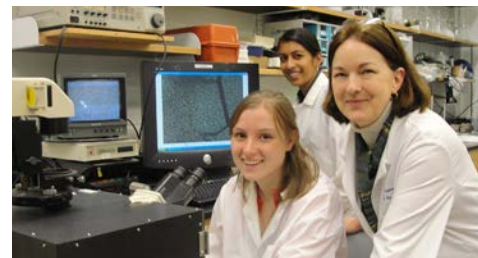

Research experiences for undergraduates.

EDUCATION AND OUTREACH

THE ADVANCED ENERGY CONFERENCE SERIES: A HISTORY OF GROWTH AND SUCCESS

Individuals Attending

	2007	2008	2009	2010	2011	2012*	2013	2014	2016	2018
Attendees	270	960	1080	1441	443	1640	1662	684	1624	1230

Corporate/Organizational Participation

	2007	2008	2009	2010	2011	2012*	2013	2014	2016	2018
Participants	100	375	466	533	214	237	254	403	696	488

*Advanced Energy 2012 canceled due to Hurricane Sandy (estimated)

Individuals Presenting

	2007	2008	2009	2010	2011	2012*	2013	2014	2016	2018
Presenters	21	136	192	232	123	342	369	129	298	213

Academic Participation

	2007	2008	2009	2010	2011	2012*	2013	2014	2016	2018
Colleges/ Universities	6	17	31	37	25	31	72	29	45	35
Posters	8	36	48	59	37	60	96	30	85	46

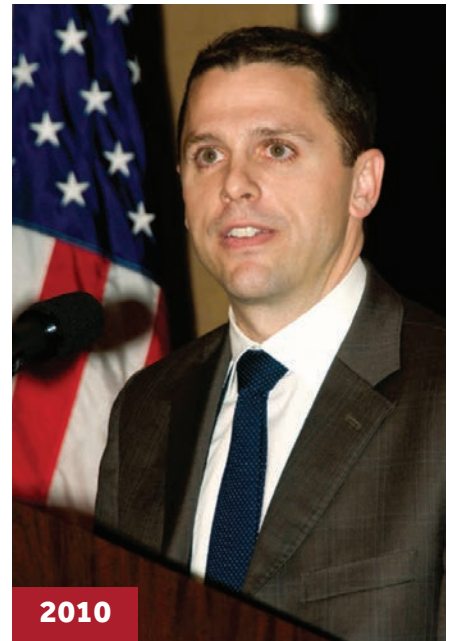

EDUCATION AND OUTREACH

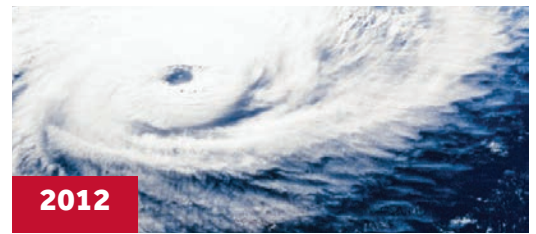
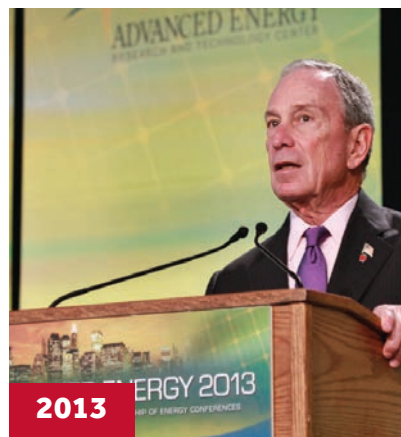
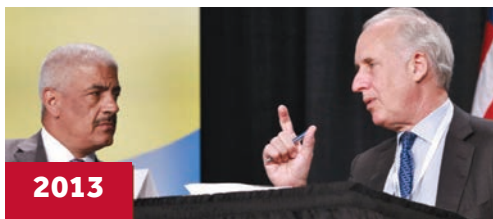

RESEARCHERS

Abdelaziz, Sherif
Civil Engineering
Stony Brook University
Sherif.Abdelaziz@stonybrook.edu

Adzic, Radoslav
Brookhaven National Laboratory
adzic@bnl.gov

Alkhader, Maen
Mechanical Engineering
Stony Brook University
Maen.Alkhader@stonybrook.edu

Aronson, Sam
BNL Past Director
samaronson@bnl.gov

Assanis, Dennis
University of Delaware
president@udel.edu

Balasubramanian, Aruna
Department of Computer Science
Stony Brook University
arunab@cs.stonybrook.edu

Bender, Michael
Computer Science
Stony Brook University
bender@cs.stonybrook.edu

Butcher, Thomas
Brookhaven National Laboratory
butcher@bnl.gov

Carbunar, Bogdan
Florida International University
carbunar@cs.fiu.edu

Chang, Qing
Mechanical Engineering
Stony Brook University
Qing.Chang@stonybrook.edu

Chen, Jingguang
Columbia University
jc3972@columbia.edu

Chu, Benjamin
Chemistry
Stony Brook University
Benjamin.Chu@stonybrook.edu

Chu, Yong
Brookhaven National Laboratory
ychu@bnl.gov

Chyu, Minking K.
University of Pittsburgh
mkchyu@pitt.edu

Cotlet, Mircea
Brookhaven National Laboratory
cotlet@bnl.gov

Cubaud, Thomas
Mechanical Engineering
Stony Brook University
Thomas.Cubaud@stonybrook.edu

DeLeon, Francisco
New York University
fdeleon@nyu.edu

Domijan, Alex
University at Buffalo
adomijan@buffalo.edu.

Driscoll, Mark
SUNY-ESF
mdriscol@esf.edu

Dvorkin, Yury
New York University
dvorkin@nyu.edu

Feinberg, Eugene
Applied Mathematics and Statistics
Stony Brook University
Eugene.Feinberg@stonybrook.edu

Ferdman, Michael
Computer Science
Stony Brook University
mferdman@cs.stonybrook.edu

Frenkel, Anatoly
Material Science and Chemical Engineering
Stony Brook University
Anatoly.Frenkel@stonybrook.edu

Gan, Hong
Brookhaven National Laboratory
hgan@bnl.gov

Gouzman, Mikhail
Electrical Engineering
Stony Brook University
Mikhail.Gouzman@stonybrook.edu

Grinberg, Ilya
Buffalo State College
grinbey@buffalostate.edu

Gupta, Nikhil
New York University
ngupta@nyu.edu

Halada, Gary
Materials Science and Engineering
Stony Brook University
Gary.Halada@stonybrook.edu

Hartman, Ryan
Chemical and Biomolecular Engineering
New York University

Hsiao, Benjamin
Chemistry
Stony Brook University
Benjamin.Hsiao@stonybrook.edu

Hong, Tianqi
New York University
th1275@nyu.edu

Hwang, David J.
Mechanical Engineering
Stony Brook University
David.Hwang@stonybrook.edu

Jang, Sung Gheel
Sustainability Studies Program
Stony Brook University
Sunggheel.Jang@stonybrook.edu

Jerschow, Alexj
New York University
alexej.jerschow@nyu.edu

Johnson, Robert
Computer Science
Stony Brook University
rob@cs.stonybrook.edu

Kaufman, Arie
Computer Science
Stony Brook University
Arie.Kaufman@stonybrook.edu

Khalifah, Peter
Chemistry
Stony Brook University
Brookhaven National Laboratory
Peter.Khalifah@stonybrook.edu

Kim, Tae Jin
Chemical and Molecular Engineering
Stony Brook University
Taejin.Kim@sunysb.edu

Knopf, Daniel
Chemistry
Stony Brook University
Daniel.Knopf@stonybrook.edu

Kulia, Debasish
North Carolina A&T
dkulia@ncat.edu

Lawler, Benjamin
Mechanical Engineering
Stony Brook University
Benjamin.Lawler@stonybrook.edu

Longtin, Jon
Mechanical Engineering
Stony Brook University
Jon.Longtin@stonybrook.edu

Luryi, Serge
Electrical and Computer Engineering
Stony Brook University
Serge.Luryi@stonybrook.edu

Mahajan, Devinder
Materials Science and Engineering
Stony Brook University
Brookhaven National Laboratory
Devinder.Mahajan@stonybrook.edu

Mamalis, Sotirios
Mechanical Engineering
Stony Brook University
Sotirios.Mamalis@stonybrook.edu

Marschilok, Amy C.
Materials Science and Engineering
Stony Brook University
Amy.Marschilok@stonybrook.edu

Modestino, Miguel
New York University
modestino@nyu.edu

Mueller, Klaus
Computer Science
Stony Brook University
Klaus.Mueller@stonybrook.edu

Nuzzo, Ralph
University of Illinois at Urbana-Champaign
r-nuzzo@illinois.edu

Oh, Hyungseon
University at Buffalo
hso1@buffalo.edu

Orlov, Alexander
Materials Science and Engineering
Stony Brook University
Alexander.Orlov@stonybrook.edu

Rafailovich, Miriam
Materials Science and Engineering
Stony Brook University
Miriam.Rafailovich@stonybrook.edu

Robertazzi, Thomas
Electrical and Computer Engineering
Stony Brook University
Thomas.Robertazzi@stonybrook.edu

Rodriguez, Jose
Brookhaven National Laboratory
rodriguez@bnl.gov

Salman, Emre
Electrical and Computer Engineering
Stony Brook University
Emre.Salman@stonybrook.edu

Samuilov, Vladimir
Materials Science and Engineering
Stony Brook University
Vladimir.Samuilov@stonybrook.edu

Samulyak, Roman
Applied Mathematics and Statistics
Stony Brook University
Brookhaven National Laboratory
Roman.Samulyak@stonybrook.edu

Schoonen, Martin
Geosciences
Stony Brook University
Martin.Schoonen@stonybrook.edu

Shamash, Yacov
VP, Economic Development
Stony Brook University
Yacov.Shamash@stonybrook.edu

Sion, Radu
Computer Science
Stony Brook University
Radu.Sion@stonybrook.edu

Skiena, Steve
Computer Science
Stony Brook University
skiena@cs.sunysb.edu

Smolka, Scott A.
Computer Science
Stony Brook University
Scott.Smolka@stonybrook.edu

Solovyov, Vyacheslav
Center for Integrated Electric Energy System
Stony Brook University
Vyacheslav.Solovyov@stonybrook.edu

Somasundaran, P.
Columbia University
ps24@columbia.edu

Sun, Guodong
Technology and Society
Stony Brook University
Guodong.Sun@stonybrook.edu

Stoller, Scott
Computer Science
Stony Brook University
Scott.Stoller@stonybrook.edu

Takeuchi, Esther S.
Materials Science and Engineering
Stony Brook University
Esther.Takeuchi@stonybrook.edu

Takeuchi, Kenneth J.
Chemistry
Stony Brook University
Kenneth.Takeuchi.1@stonybrook.edu

Tonjes, David
Technology and Society
Stony Brook University
David.Tonjes@stonybrook.edu

Trelewicz, Jason
Materials Science and engineering
Stony Brook University
Jason.Trelewicz@stonybrook.edu

Turn, Scott
University of Hawaii
sturn@hawaii.edu

Venkatesh, T. A.
Materials Science and Engineering
Stony Brook University
T.Venkatesh@stonybrook.edu

Wang, Lifeng
Mechanical Engineering
Stony Brook University
Lifeng.Wang@stonybrook.edu

Weyant, Christopher
Materials Science and Engineering
Stony Brook University
Christopher.Weyant@stonybrook.edu

White, Michael
Chemistry
Stony Brook University
Brookhaven National Laboratory
Michael.White@stonybrook.edu

Worek, William
Mechanical Engineering
Texas A & M University
william.worek@tamu.edu

Yang, Yi
New York University
yy1160@nyu.edu

Zadok, Erez
Computer Science
Stony Brook University
Erez.Zadok@stonybrook.edu

Zaitsev, Vladimir
Materials Science and Engineering
Stony Brook University
Vladimir.Zaitsev@stonybrook.edu

Zhou, Yu
Mechanical Engineering
Stony Brook University
Yu.Zhou.1@stonybrook.edu

Zuo, Lei
Virginia Tech
leizuo@vt.edu

Stony Brook University is an affirmative action/equal opportunity educator and employer. This publication can be made available in an alternative format upon request.
© 2019 Stony Brook University.

"In fulfillment of its multi-program mission, the Advanced Energy Center™ has fostered technology development collaborations throughout New York. The Center brings together the state's best-qualified researchers and educators for its programs, projects and outreach activities.

The synergies of these remarkable diversity of State-wide efforts have produced an exceptional range of results across the spectrum of advanced energy research."

—Dr. Yacov Shamash
Vice President for
Economic Development
Stony Brook University



ADVANCED ENERGY™
Research and Technology Center

AT STONY BROOK UNIVERSITY

Advanced Energy Research and Technology Center™
Research and Development Park
1000 Innovation Road
Stony Brook, NY 11794-6044
(631) 216-7400

www.aertc.org



Stony Brook University

BROOKHAVEN
NATIONAL LABORATORY



Division of
Science, Technology
& Innovation



This guide is printed on FSC-certified paper with 50% recycled and 25% post-consumer content, using vegetable-based inks.

January 2019